



## M Series Amplifiers

M30D / M30D HDSP+ETH

M20D / M20D HDSP+ETH

MI4D / MI4D HDSP+ETH

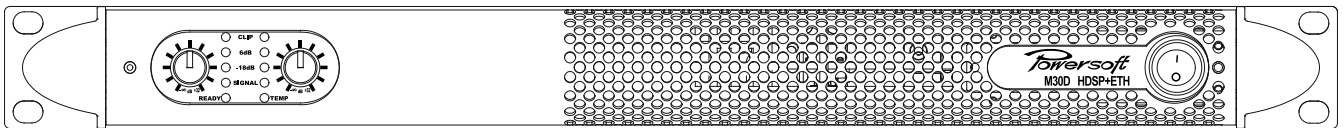

M50Q / M50Q HDSP+ETH

M28Q / M28Q HDSP+ETH

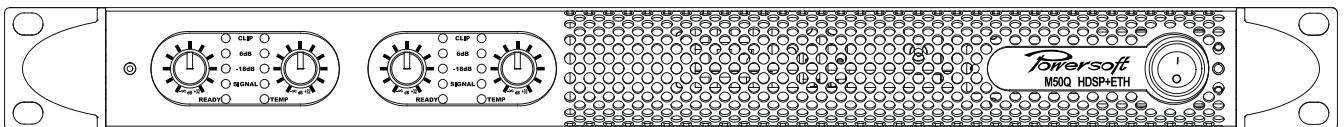

## USER GUIDE

March 2014

# M Series

User guide

## Table of contents

<b>1</b>	<b>Important safety instructions</b>	<b>4</b>	<b>9</b>	<b>M Series HDSP+ETH operation</b>	<b>12</b>
<b>2</b>	<b>Precautions regarding installation</b>	<b>4</b>	9.1	Rear Panel LEDs	12
2.1	Location	4	9.2	Ethernet port and remote ID selection	12
2.2	Inrush current	5	9.3	V Ext	12
2.3	Wiring	5	9.4	DSP features and operations	12
2.4	Main power switch	5	9.4.1	DSP Features	12
2.5	Speker damage	5	9.4.2	Input routing selection and internal signal route	13
<b>3</b>	<b>Technical drawings</b>	<b>6</b>	9.4.3	Input section	13
<b>4</b>	<b>Interfaces</b>	<b>7</b>	9.4.4	Output section	13
<b>5</b>	<b>Welcome</b>	<b>9</b>	9.5	Internal processing layout	13
<b>6</b>	<b>The M Series</b>	<b>9</b>	9.5.1	Input routing	13
6.1	More sound and less weight	9	9.5.2	Input section	13
<b>7</b>	<b>Installation</b>	<b>9</b>	9.5.3	Output section	13
7.1	Unpacking	9	9.6	Locking	14
<b>8</b>	<b>Connections and Operation</b>	<b>10</b>	9.7	On/Off	14
8.1	Front panel air filters access	10	9.8	Preset Management	14
8.2	Mounting	10	<b>10</b>	<b>Remote control</b>	<b>14</b>
8.3	Cooling	10	10.1	Networking	14
8.4	Operating precautions	10	10.1.1	Discovery device	14
8.5	Grounding	10	10.1.2	DHCP	14
8.6	AC mains connection	10	10.1.3	AUTOIP	15
8.2	Front panel adjustments	11	10.1.4	Static IP	15
8.3	Front panel monitoring	11	10.1.5	Revert from static IP	15
8.4	Connecting audio inputs	11	10.2	Setup device	16
8.4.1	MxxD models	11	10.2.1	Virtual device	16
8.4.2	MxxQ models	11	10.2.2	Configure layout	16
8.5	Connecting audio outputs	11	10.2.3	Real device	16
8.5.1	Lo-Z and 70V/100V operations	11	10.3	File operations	17
8.5.2	Bridge Mode Connection	11	10.3.1	Binary preset file .preset	17
			10.4	Input/output curves .icp, .ocp	17
			10.5	Channel preset .chp	17
			10.6	Device preset file .pam	17
			10.7	System File .paw	18

10.8 DSP remote operations	18	<b>15 M Series power rating</b>	<b>23</b>
10.8.1 Routing	18	<b>16 Output SpeakON connection polarities</b>	<b>23</b>
10.8.2 Input eq	18	<b>17 M Series load compatibility chart</b>	<b>23</b>
10.8.3 Output eq	19	<b>18 M Series block diagram</b>	<b>24</b>
10.8.4 Limiters	19	<b>19 Specifications</b>	<b>25</b>
10.8.5 RMS limiter	19	<b>Annex A: IP management and recovery</b>	<b>30</b>
10.8.6 Peak limiter	19	A.1 Setting an IP policy on Adu based devices	
10.14.1 Damping factor correction	20	with an external Lantronix tool	30
10.9 Locking	20	A.1.1 Reset IP configuration	30
10.10 On board preset operations	20		
10.11 Copy and paste operations	20		
10.12 Input/output eq curves	20		
10.13 Channels	21		
10.14 Workspace	21		
<b>11 Protection</b>	<b>21</b>		
11.1 Turn on/Turn off muting	21		
11.2 Short circuit protection	21		
11.3 Thermal protection	21		
11.4 Thermal warning	21		
11.5 Thermal shutdown	21		
<b>14 Assistance</b>	<b>22</b>		
11.6 DC fault protection	22		
11.7 Input/output protection	22		
<b>12 User Maintenance</b>	<b>22</b>		
12.1 Cleaning	22		
12.2 Service	22		
12.3 Dust Removal	22		
<b>13 Warranty</b>	<b>22</b>		
13.1 Product warranty	22		
13.2 Return of Goods	22		
13.3 Repair or replacement	22		
13.4 Cost and responsibility of transport	22		

## I Important safety instructions



**CAUTION:** TO REDUCE THE RISK OF ELECTRIC SHOCK, DO NOT ATTEMPT TO OPEN ANY PART OF THE UNIT. NO USER-SERVICEABLE PARTS INSIDE. REFER SERVICING TO QUALIFIED SERVICE PERSONNEL.

**WARNING:** TO REDUCE THE RISK OF FIRE OR ELECTRIC SHOCK, DO NOT EXPOSE THIS APPARATUS TO RAIN OR MOISTURE. OBJECTS FILLED WITH LIQUIDS, SUCH AS VASES, SHOULD NOT BE PLACED ON THIS APPARATUS.

TO COMPLETELY DISCONNECT THIS APPARATUS FROM THE AC MAINS, DISCONNECT THE POWER SUPPLY CORD PLUG FROM THE AC RECEPTACLE.

THE MAINS PLUG OF THE POWER SUPPLY CORD MUST REMAIN READILY ACCESSIBLE.

**SAFEGUARDS:** This unit has been engineered and manufactured to assure your personal safety. Improper use can result in potential electrical shock or fire hazards. In order not to defeat the safeguards, observe the following instructions for its installation, use and servicing.

1. Read these instructions.
2. Keep these instructions.
3. Heed all warnings.
4. Follow all instructions.
5. Do not use this amplifier near water.
6. Clean only with a dry cloth.
7. Do not block any ventilation openings. Install in accordance with the manufacturer's instructions.
8. Do not install near any heat sources such as radiators, heat registers, stover or other apparatus (including amplifiers) that produce heat.
9. Do not defeat the safety purpose of the polarized or grounding-type plug. A polarized plug has two blades with one wider than the other. A grounding type plug has two blades and a third grounding prong. The wide blade or the third prong are provided for your safety. If the provided plug does not fit into your outlet, consult an electrician for replacement of the obsolete outlet.
10. Protect the power cord from being walked on or pinched particularly at plugs, convenience receptacles, and the point where they exit from the apparatus.
11. Only use attachments/accessories specified by the manufacturer.
12. Use only with the cart, stand, tripod, bracket or table specified by the manufacturer, or sold with the apparatus. When a cart is used, use caution when moving the cart/apparatus combination to avoid injury from tip-over.



**NOTES:** This equipment has been tested and found to comply by Competent Body (Directive 2004/108/EC) pursuant to the product family standard for audio professional use: EN 55103-1 and EN 55103-2 standard.

This equipment has been tested and found to comply by Notified Body 2014 (Directive 2006/95/EC) pursuant to the audio apparatus safety requirements: EN 60065 and EN 6006/A1 standard. Electromagnetic environments E4, E5.

This equipment has been tested and found to comply with the limits for Class A digital device, pursuant to Part 15 of the FCC rules. These limits are designed to provide reasonable protection against harmful interference when the equipment in question is used in a commercial environment.

This equipment generates and uses radio frequency energy and may cause harmful interference to radio communications if not installed and used in accordance with the recommendations of the instruction manual.

The use of this equipment in a residential area may cause harmful interference that the user will be required to correct at his own expense if necessary.

### User instructions

Alterations or modifications to the equipment without proper authorization can void the user's authority to operate the equipment and/or the equipment warranty.

### EXPLANATIONS OF GRAPHICAL SYMBOLS



The Lightning Flash with arrowhead symbol within an equilateral triangle is intended to alert the user to the presence of uninsulated "dangerous voltage" within the product enclosure that may be of sufficient magnitude to constitute a risk of shock to persons.



The Exclamation Point within an equilateral triangle is intended to alert the user to the presence of important operating and maintenance (servicing) instructions in the literature accompanying the product.

## 2 Precautions regarding installation

### 2.1 Location





Install the amplifier in a well-ventilated location where it will not be exposed to high temperature or humidity.

Do not install the amplifier in a location that is exposed to direct sun rays, or near hot appliances or radiators. Excessive heat can adversely affect the cabinet and internal components. Installation of the amplifier in a damp or dusty environment may result in malfunction or accident.



Placing and using the amplifier for long periods of time on heat generating sources will affect its performance. Avoid placing the amplifier on heat generating sources. Install this amplifier as far as possible from tuners and TV sets. An amplifier installed in close proximity of such equipment may experience noise or generic performance degradation.

 No naked flame sources such as lighted candles should be placed on the amplifier.  
Do not spill water or other liquids into or on the amplifier.

 **WARNING**  
To prevent fire or electric shock:

- ▶ The ventilation openings must not be impeded by any item such as newspapers, tablecloths, curtains etc; keep a distance of at least 50 cm from the front and rear ventilation openings of the amplifier.
- ▶ Do not expose this amplifier to rain or moisture.
- ▶ This equipment must not be exposed to dripping or splashing liquids: objects filled with liquids, such as vases, must not be placed on the amplifier.

## 2.2 Inrush current

 Average half-cycle r.m.s. inrush current on initial switch-on:

M14D and M14D HDSP+ETH: 28 A<sub>rms</sub>  
M20D and M20D HDSP+ETH: 35 A<sub>rms</sub>  
M30D and M30D HDSP+ETH: 36 A<sub>rms</sub>

M28Q and M28Q HDSP+ETH: 30 A<sub>rms</sub>  
M50Q and M50Q HDSP+ETH: 39 A<sub>rms</sub>

 Average half-cycle r.m.s. inrush current after a supply interruption of 5 seconds:

M14D and M14D HDSP+ETH: 13 A<sub>rms</sub>  
M20D and M20D HDSP+ETH: 15 A<sub>rms</sub>  
M30D and M30D HDSP+ETH: 16 A<sub>rms</sub>

M28Q and M28Q HDSP+ETH: 14 A<sub>rms</sub>  
M50Q and M50Q HDSP+ETH: 18 A<sub>rms</sub>

## 2.3 Wiring

 This device must be powered exclusively by earth connected mains sockets in electrical networks compliant to the IEC 364 or similar rules. It is absolutely necessary to verify this fundamental requirement of safety and, in case of doubt, require an accurate check by qualified personnel.

**POWERSOFT cannot be considered responsible for eventual damages caused to persons, things or data due to an improper or missing ground connection.**

- ▶ Before powering this amplifier, verify that the correct voltage rating is being used.
- ▶ Verify that your mains connection is capable of satisfying the power ratings of the device.
- ▶ Do not use this amplifier if the electrical power cord is frayed or broken.

- ▶ Do not remove the cover. Failing to do so will expose you to potentially dangerous voltage.
- ▶ Provide a sectioning breaker between the mains connections and the amplifier. The suggested device is a 16A/250V AC, C or D curve, 10 kA.
- ▶ Switching mode amplifier is capable of producing hazardous output voltages. To avoid electrical shock, do not touch any exposed speaker wiring while the amplifier is operating.

## CLASS2 WIRING

 **CLASS2 WIRING**  
Output terminals are hazardous: wiring connection to these terminals require installation by an instructed person and the use of ready made leads.

**Take care to secure the output terminal before switching the device on.**

## 2.4 Main power switch

 The main power switch on this unit does not provides a complete insulation of the equipment from the main power. You must disconnect the main power source to turn off all power. So make sure that the unit has been installed so that the power cord can be easily disconnected from the outlet in case of accident. To avoid fire hazard, the power cord should also be unplugged from the outlet when the device is not used for a long period (for example, when you go on vacation).

## 2.5 Speaker damage

 Powersoft switching mode amplifiers are among the most powerful professional amplifiers available and are capable of producing much more power than many loudspeakers can handle. It is the user's responsibility to use speakers suitable to the amplifier and to use them in a sensible way that will not cause damage

**Powersoft will not be held responsible for damaged speakers. Consult the speaker manufacturer for power handling recommendations.**

Even if you reduce the output volume using the amplifier's front panel attenuation controls, it is still possible to reach full output power if the input signal level is high enough.

A single high-power tone can damage high frequency drivers almost instantaneously, while low frequency drivers can usually withstand very high, continuous power levels for a few seconds before they fail. Reduce power immediately if you hear any speaker "bottoming out": harsh pops or cracking distortion that indicate that the speaker voice coil or diaphragm is striking the magnet assembly.

**This manual contains important information on operating your Powersoft amplifier correctly and safely. Please read it carefully before operating your amplifier. If you have any questions, contact your Powersoft dealer.**

### 3 Technical drawings

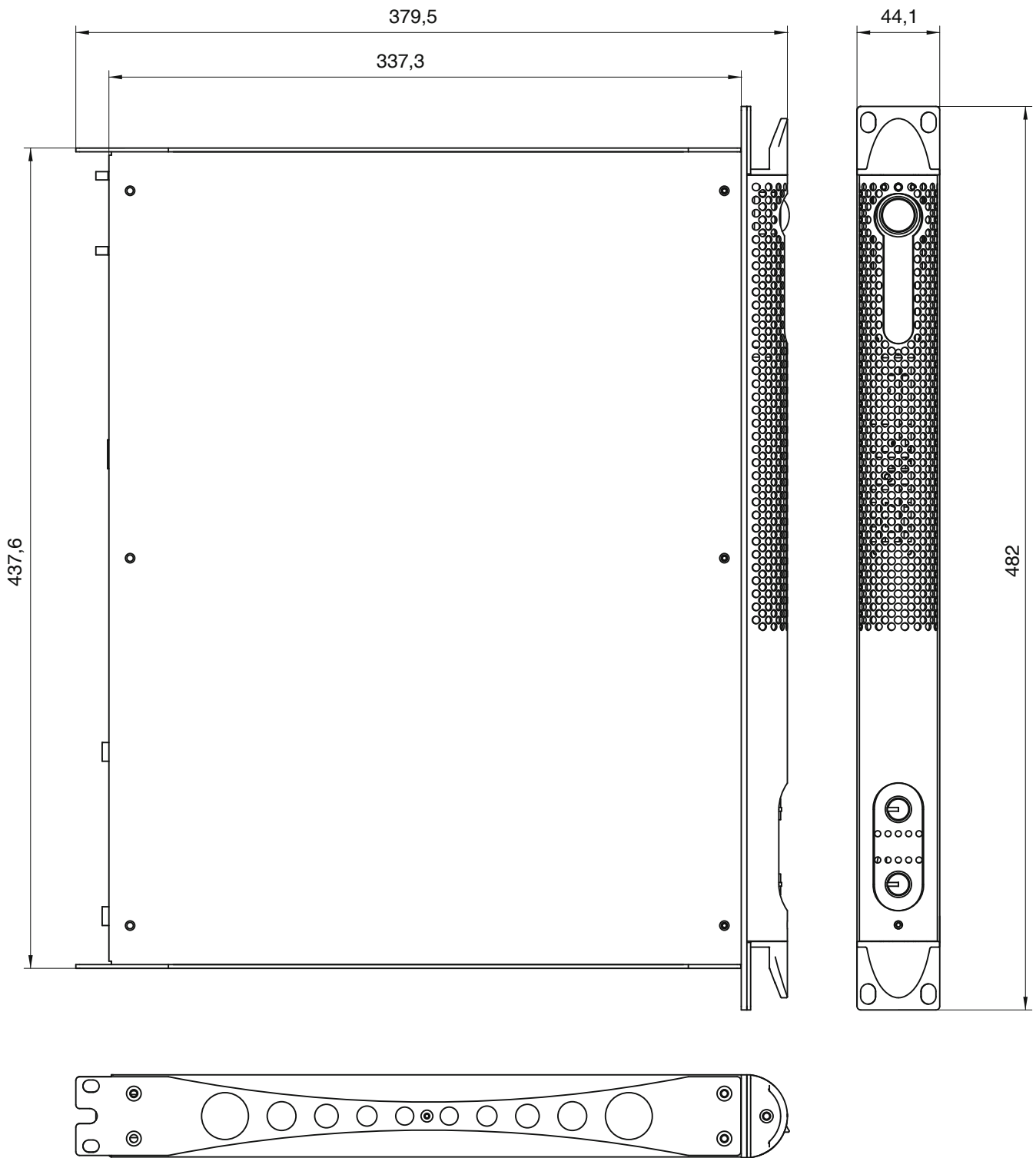

FIGURE 1: M Series mechanical drawing. All dimensions in millimeters.

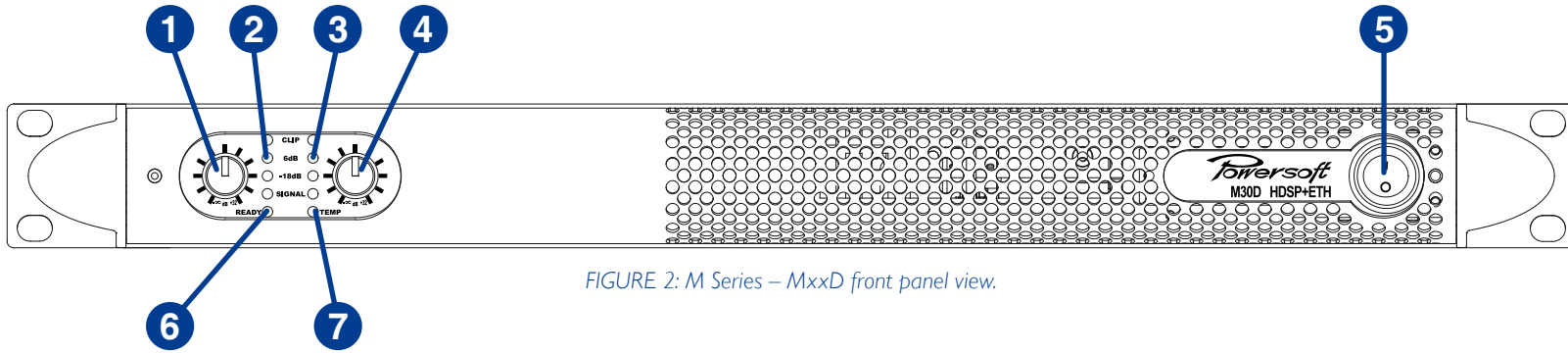

FIGURE 2: M Series – MxxD front panel view.

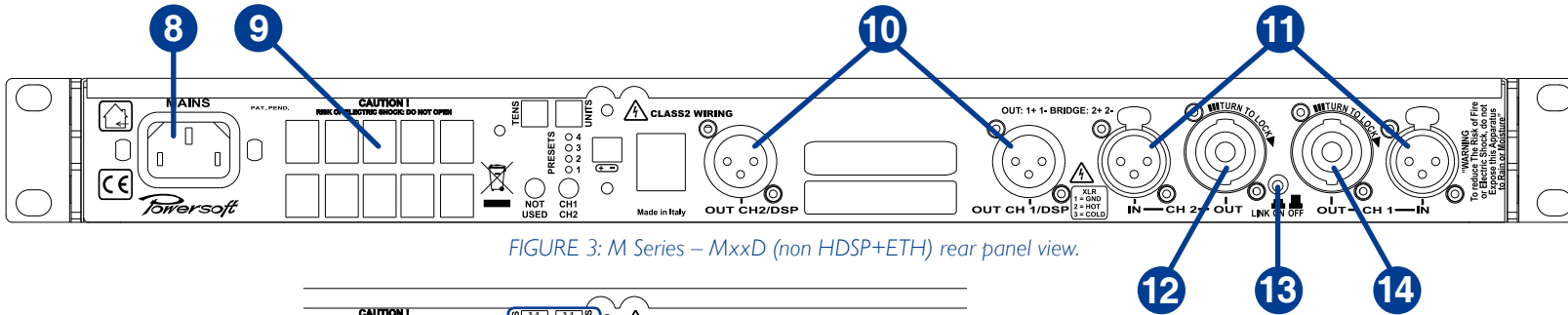

FIGURE 3: M Series – MxxD (non HDSP+ETH) rear panel view.

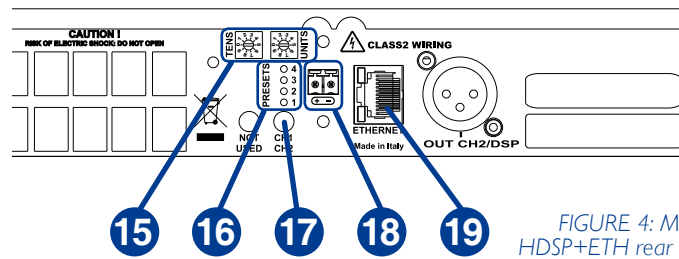

FIGURE 4: M Series HDSP+ETH rear panel view.

- |  |   |   |
|--|---|---|
| <ul style="list-style-type: none"> <li>1. Channel 1 input attenuator</li> <li>2. Channel 1 meter LEDs</li> <li>3. Channel 2 meter LEDs</li> <li>4. Channel 2 input attenuator</li> <li>5. On/off power switch</li> <li>6. Channels 1&amp;2 ready LED</li> <li>7. Channels 1&amp;2 temperature warning LED</li> </ul> | <ul style="list-style-type: none"> <li>8. AC mains power plug</li> <li>9. Air vents</li> <li>10. Channels 1&amp;2 line output XLR connector</li> <li>11. Channels 1&amp;2 line input XLR connector</li> <li>12. Channel 2 output Speakon connector</li> <li>13. Link switch channels 1-2</li> <li>14. Channel 1 output Speakon connector</li> </ul> | <ul style="list-style-type: none"> <li>15. Amplifier's remote ID selector</li> <li>16. Preset LEDs</li> <li>17. Preset selector button</li> <li>18. AUX supply plug</li> <li>19. Ethernet port</li> </ul> |
|--|---|---|

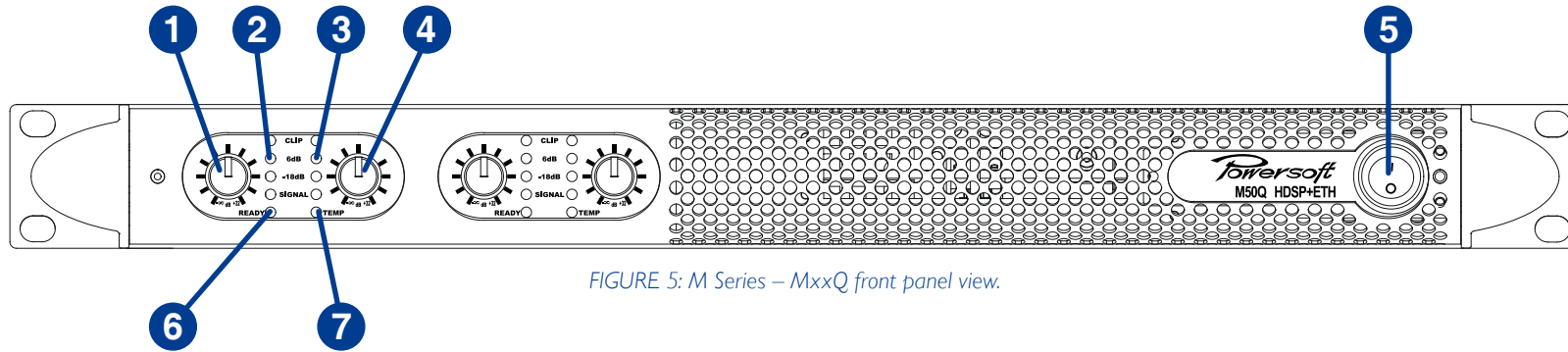

FIGURE 5: M Series – MxxQ front panel view.

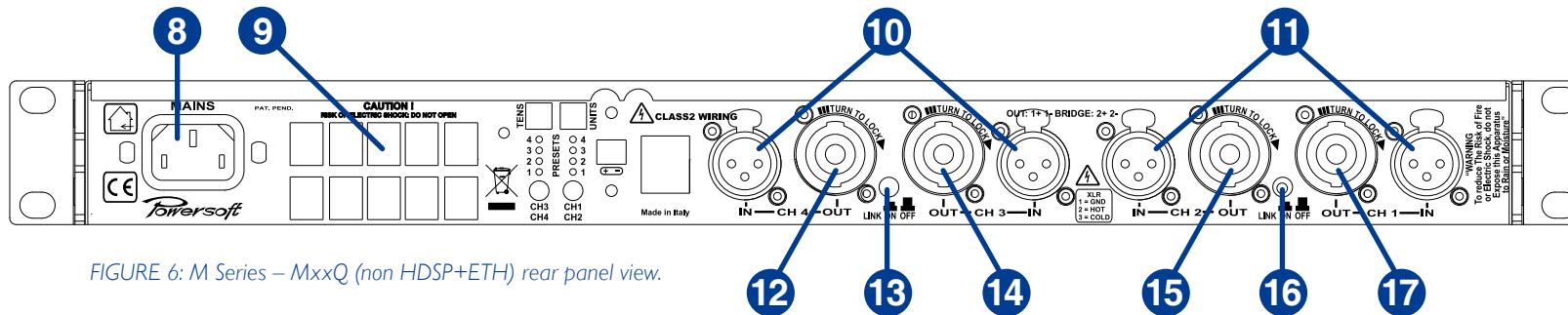

FIGURE 6: M Series – MxxQ (non HDSP+ETH) rear panel view.

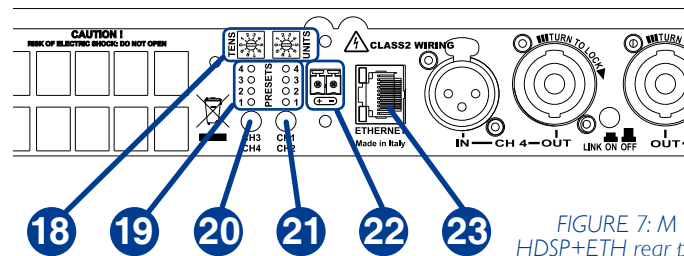

FIGURE 7: M Series HDSP+ETH rear panel view.

- |   |   |   |
|---|---|---|
| 1. Channel 1 input attenuator           | 10. Channels 3&4 line input XLR connector | 18. Amplifier's remote ID selector      |
| 2. Channel 1 meter LEDs                 | 11. Channels 1&2 line input XLR connector | 19. Preset LEDs                         |
| 3. Channel 2 meter LEDs                 | 12. Channel 4 output Speakon connector    | 20. Preset selector button channels 3&4 |
| 4. Channel 2 input attenuator           | 13. Link switch channels 3-4              | 21. Preset selector button channels 1&2 |
| 5. On/off power switch                  | 14. Channel 3 output Speakon connector    | 22. AUX supply plug                     |
| 6. Channels 1&2 ready LED               | 15. Channel 2 output Speakon connector    | 23. Ethernet port                       |
| 7. Channels 1&2 temperature warning LED | 16. Link switch channels 1-2              |   |
| 8. AC mains power plug                  | 17. Channel 1 output Speakon connector    |   |
| 9. Air vents                            |   |   |



# M Series

## User guide

### 5 Welcome

Congratulations on buying a Powersoft M Series amplifier! Powersoft is a leading company in the field of high efficiency audio power management. The Powersoft Class D technology has changed the way the world looks at professional audio amplification: no other amplifier's performance comes close for applications demanding high power and long term reliability.

Thanks to amazing reductions in heat output and weight, without sacrificing output powers, Powersoft amplifiers can be used in an unlimited range of PA applications such as opera houses, theaters, churches, cinema, and theme parks.

### 6 The M Series

M Series amplifiers are specifically designed for touring and live applications. The amplifiers in this series offer smaller dimensions, lighter weight and the traditionally amazing sound quality and reliability of all Powersoft products. M Series amplifiers have power ratings suitable for a vast range of common applications including 70V/100V distributed line systems.

#### 6.1 More sound and less weight

Switching mode technology based amplifiers are highly efficient, delivering greater power to speakers with reduced heat dissipation: typical running efficiency of output stages is 95%, with only 5% of input energy dissipated as heat. This allows for smaller dimensions, weight and power consumptions.

Contrary to conventional amplifiers which achieve highest efficiency only at full rated power output, Class D efficiency is almost independent of output level. Music has an average power density of 40% of its peak value; this means that other (non-Class D) amplifiers can easily generate 10 times more heat than Powersoft products for the same sound pressure level.

The units in the M Series are designed to work with lo-Z (starting from 4  $\Omega$ ) and with 70V/100V distributed lines. They can deliver up to 1500 W @ 4  $\Omega$  per channel or 3000 W in bridge mode on 8  $\Omega$ . The HDSP+ETH versions of all amplifiers in this series allow single channel processing and remote control capabilities.

Powersoft amplifiers deliver crystal-clear highs, and a tight, well-defined low end: the most accurate reproduction of an audio signal. Solid time proven design features ensure extremely high

performance in terms of super low total harmonic distortion, optimal frequency response, high power bandwidth and damping factor across a vast number of application scenarios. Powersoft's multi patented application of Pulse Width Modulation (PWM) high frequency sampling techniques is just one of the many factors contributing to the M Series' high performance ratings across the audio bandwidth.

The M Series offers complete protection against any possible operation error. Every amplifier in this series is designed to work under a large range of possible conditions, delivering maximum power with maximum safety and an outstanding long term reliability. Anticipating potential problems at the design stage means your show always goes on!

### 7 Installation

#### 7.1 Unpacking

The [FIGURE 8](#) shows the packing view. Every Powersoft amplifier is completely tested and inspected before leaving the factory and should arrive in pristine condition. In the unlikely event that you should encounter any damage, please notify the shipping company immediately. Be sure to save all packing materials for the carrier's inspection.

Every M Series amplifier box contains the following:

- ▶ 1 M Series amplifier.
- ▶ 1 x AC Mains cord with 3-pin plug 15 A for US or IEC 'Schuko' 16 A for every other nation.
- ▶ 1 x User Guide.

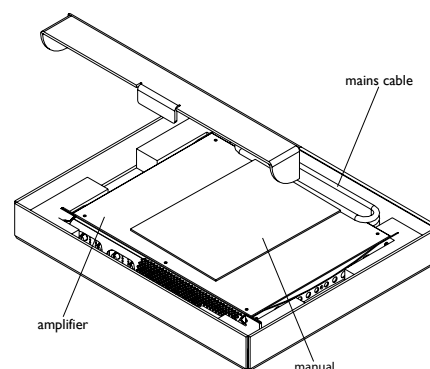
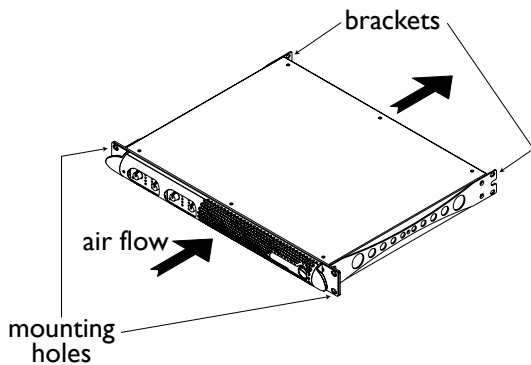

FIGURE 8: M Series package.

## 7.2 Mounting

All Powersoft amplifiers are designed for standard 19" rack mounting with four front panel holes and two rear-lateral holes. In order to limit the risk of mechanical damages, amplifiers must be fixed to the rack using both frontal as well as rear mounting holes (ref. [FIGURE 9](#)).



*FIGURE 9: Circulation d'air des M Series.*

## 7.3 Cooling

All Powersoft amplifiers implement a forced-air cooling system to maintain low and constant operating temperatures. Drawn by an internal fan, air enters through the slots in the front panel and is forced over all components, exiting at the back of the amplifier.

The amplifier's cooling system features an "intelligent" variable-speed DC fan which is controlled by heat sink temperature sensing circuits: the fan speed will increase only when the temperature recorded by the sensors rises over carefully predetermined values. This ensures that fan noise and internal dust accumulation are kept to a strict minimum. Should however the amplifier be subject to an extreme thermal load, the fan will force a very large volume of air through the heat sink. In the extremely rare event that the amplifier should dangerously overheat, sensing circuits shut down all channels until the amplifier cools down to a safe operating temperature. Normal operation is resumed automatically without the need for user intervention.

Caution regarding heat escape should be exercised when mounting M Series amplifiers. Exhaust cooling air is forced out through the rear of the chassis (ref. [FIGURE 9](#)); make sure there is enough space around the back of the amplifier for this air to escape. M Series amplifiers can be stacked one on top of the other due to the efficient cooling system they are equipped with. There is however a safety limit to be observed: in case a rack with closed back panels is used, leave one rack unit empty every four installed amplifiers to guarantee adequate air flow.

## 7.4 Operating precautions

Make sure the power switch is off before attempting to make any input or output connections.

Make sure the AC mains voltage used is within the acceptable operating voltage range specified in the M Series documentation (factory selected 115 V / 230 V  $\pm$ 15%), depending on your country mains standard. Damage caused by connecting the amplifier to an improper AC mains voltage is not covered by the warranty.

By using good quality input and speaker cables, the likelihood of erratic signal behavior is reduced to a minimum. Whether you make them or buy them, look for good quality wires, connectors and soldering techniques.

## 7.5 Grounding

There is no ground switch or terminal on the M Series amplifiers. All shield terminals of input connections are directly connected to the chassis. This means that the unit's signal grounding system is automatic. In order to limit hum and/or interference entering the signal path, use balanced input connections.

In the interests of safety, the unit **MUST** always operate with electrical safety earth connected to the chassis via the dedicated wire in the 3-wire cable. Never disconnect the ground pin on the AC mains power cord.

## 7.6 AC mains connection

The AC Mains connection is made via the IEC type connector on the back of the amplifier. Please make sure your AC mains power source operates within the voltage limits indicated on this manual (factory selected 115 V / 230 V  $\pm$ 15%).

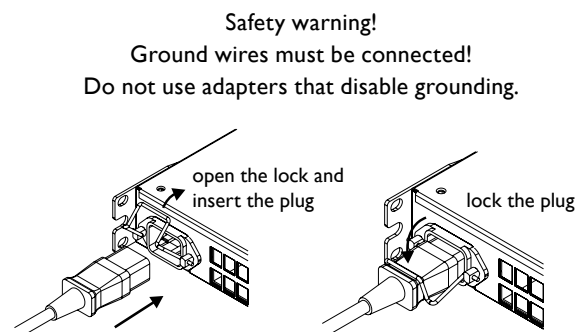

*FIGURE 10: AC mains plug connection.*

## 8 Connections and Operation

This section provides information on amplifier connection and operation. For optimal amplifier performance, it is important to understand the meaning of the information that each M Series amplifier can provide regarding its status and configuration. This information is available to the user via front panel indicators as well as through specific LEDs the back of the unit (for HDSP versions only). This chapter will break down all the front panel and back panel functions. The remaining part of the chapter will explain how to correctly connect the amplifier's inputs and outputs.

### 8.1 Front panel air filters access

The blue front panel of all M Series amplifiers can be removed to access the air filters. This is useful when the air filters need to be cleaned due to dust accumulating and clogging the filters thus hindering proper air circulation vital for cooling purposes.

To take off the blue colored front panel, remove the two screws highlighted in with a Philips screwdriver. The panel will easily separate from the amplifier exposing the sponge-like air filters.

Before replacing the front panel, remember to reposition the air filter on the chassis by placing it on its designated area, then reposition and tighten the two frontal screws.

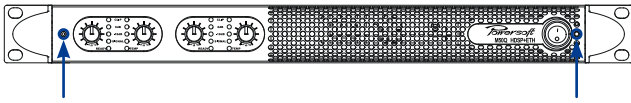

FIGURE 11: Unscrew and remove the front panel.

## 8.2 Front panel adjustments

The front panel of all M Series amplifiers has one stepped attenuation pot for each channel. Turning the pot counterclockwise, the user can modify the level of the input signal in steps corresponding to a gain reduction ranging in:  $-\infty$ , 4, 14, 18, 20, 22, 24, 26, 28, 30, 32 dB.

## 8.3 Front panel monitoring

The M Series front panel provides important information on the state of the amplifier. It is important to know and understand the meaning of every front panel indicator LED in order to have crucial information on the amplifier status.

There are two sets of LEDs on the M Series front panel: channel indicators and status indicators. Channel indicators: each channel has its own column set of 4 LEDs. The top LED is red, and the following three are green. Status indicators: each channel pair has one set of two green status indicator LEDs.

The function of both families of LEDs is summarized in [TABLE 1](#).

Channel indicators			
LED	Color	Solid ON	Label
	RED	Channel output level has reached clipping limits OR Short circuit protection has been engaged	CLIP
	GREEN	Channel output level is above -6 dB of max output level	-6 dB
	GREEN	Channel output level is above -18 dB of max output level	-18 dB
	GREEN	Input signal presence	SIGNAL
Status indicators			
LED	Color	Solid ON	Label
	GREEN	Channel is ready	READY
	YELLOW	Output power is being reduced due to heat sink temperature exceeding 75° C*	TEMP

\* Should the temperature exceeds 85° C, the LED will stay on and the channel will be muted. The amplifier will resume normal functioning and the LED will turn off automatically when the temperature falls below 75° C.

TABLE 1: M Series LEDs chart.

## 8.4 Connecting audio inputs

### 8.4.1 MxxD models

Audio input connections are made via two XLR connectors found on the rear of the amplifier. Signal looping (i.e. link thru) is possible using the two XLR male connectors which are also found on the back panel. The Link on/off button allows to connect input channels 1 and 2 in parallel.

### 8.4.2 MxxQ models

Audio input connections are made via four XLR connectors found on the rear of the amplifier. Signal looping (i.e. link thru) is possible using the two XLR male connectors which are also found on the back panel. The Link on/off buttons allows to connect input channels 1 and 2 (and/or channels 3 and 4) in parallel.

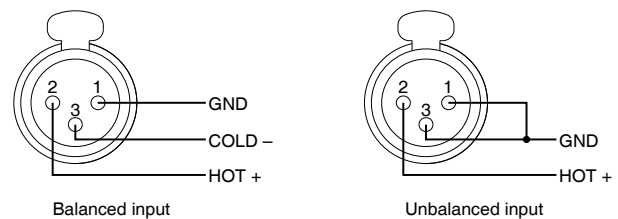

FIGURE 12: Connexion XLR d'entrée symétrique et asymétrique.

## 8.5 Connecting audio outputs

### WARNING!

**Lethal voltage levels may be present at the loudspeaker connectors when the amp is turned on!**

All output connections are made via speakON connectors. Both bridge as well as single channel output connection modes are available. In the single channel mode wiring, the I+ pin of the connector corresponds to the positive output of the channel, the I- to ground (ref. [FIGURE 13](#)); or bridge mode refer to [Section 8.5.2](#).

All 4 channel amplifier (MxxQ) manage bridge and single channel mixed configuration; for example, channels 1 and 2 can be set in bridge mode, and channels 3 and 4 single-ended.

M Series amplifiers are designed to be connected both to lo-Z loudspeakers as well as hi-Z, 70V / 100V distributed lines directly.

### 8.5.1 Lo-Z and 70V/100V operations

High impedance loudspeakers can be paralleled in 70V/100V distributed lines and directly managed by the M Series amplifiers. High output voltage per channel of M20D, M30D and M50Q amplifiers guarantees direct connection to hi-Z loudspeakers in a line (ref [FIGURE 13](#)).

### 8.5.2 Bridge Mode Connection

Bridge mode connection of outputs is possible only in lo-Z operational mode. Bridging of adjacent channels is possible for the following pairs: channels 1 with 2 for all models and channels 3 with 4 for MxxQ models. Bridging is NOT possible for other pairs, for example channels 1 and 3.

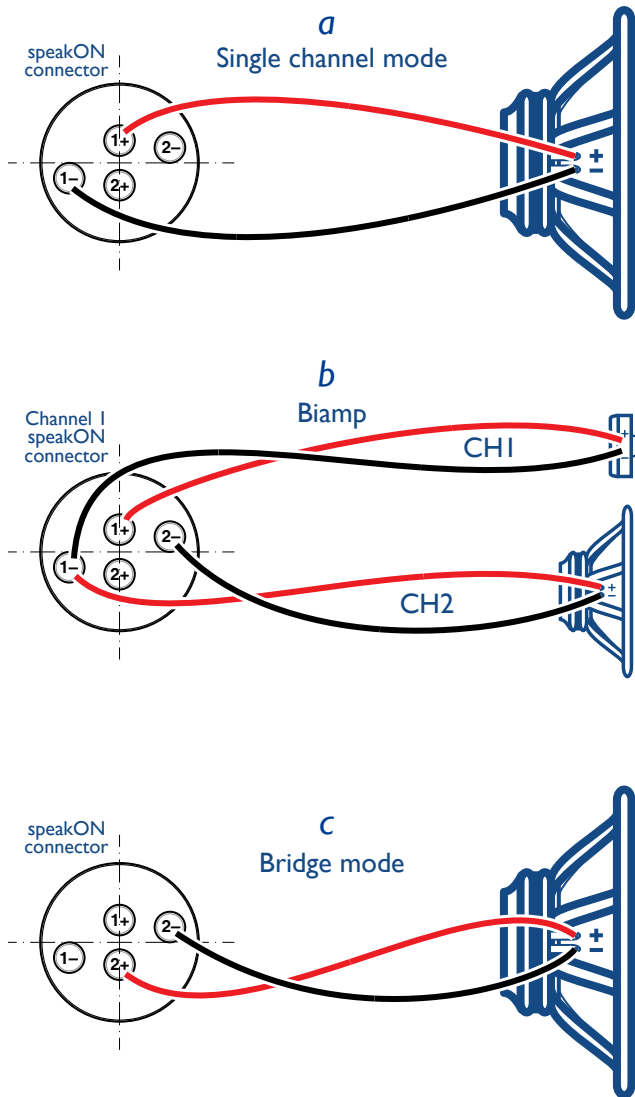

FIGURE 13: Loudspeaker wiring;  
 a) single channel mode, low impedance loudspeaker;  
 b) single channel biamplified w/ active crossover: CH1 high, CH2 low;  
 c) bridge mode.

In order to set the output in bridge mode:

- ▶ parallel the input by pressing on the link button;
- ▶ connect the loudspeaker to just one speakON: 2+ pin is the positive and the 2- the negative;
- ▶ minimum load impedance shall be 8Ω.

## 9 M Series HDSP+ETH operation

### 9.1 Rear Panel LEDs

The rear panel of the M Series with optional HDSP has a 4-green-LED column per channel pair. The LED lights to indicate which preset is active for that specific channel pair. Preset parameters are defined, set and modified by connecting the M Series amplifier with the optional HDSP to a computer running the Armonía Pro Audio Suite. In case of a 4-channel amplifier (MxxQ models), the first LED column indicates the selected preset active on channels 1 and 2, while the second column refers to the preset

selected for channels 3 and 4. A signal can be sent remotely to the amp to force all preset LEDs to blink for 30 s; this can be useful in a situation where many amplifiers are networked together and it is necessary to identify which amplifier corresponds to a particular network address.

### 9.2 Ethernet port and remote ID selection

The ID selection doesn't implement a communication function but is necessary in order to recognize the ID of the amplifier when remotely connected. This two digits number is set via the encoders by choosing tens digits through the left hand rotary selector and unit digit through the right hand rotary selector.

**ID number 00 is not allowed.**

### 9.3 V Ext

The "V Ext" plug, located on the rear panel of M HDSP Series amplifiers, is used to supply the amplifier's internal Ethernet controller with the minimum power required for remote on/off switching operations. When the V Ext port is powered by an external 9 V – 12 V DC (900 mA) power supply, the Ethernet controller is enabled to listen for incoming connections such as device power-on commands.

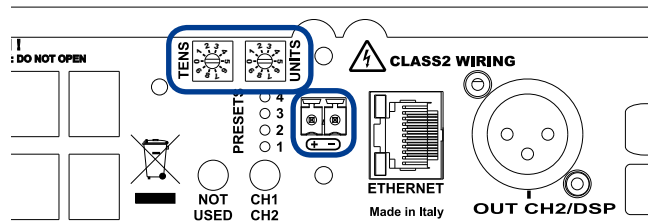

FIGURE 14: Ethernet port ID selector and VExt plug.

### 9.4 DSP features and operations

The main purpose of Digital Signal Processing (DSP) operations is to allow the end user to program signal handling and processing in order to:

- ▶ Select and handle the source signal;
- ▶ Process the signal for system operationM
- ▶ Process the signal to improve multi way speaker sound quality and protect speaker drivers.

Furthermore, the DSP allows access to real-time information on the internal device operation. This provides the end user with reliable information on the internal state of the device as well as better and faster amplifier response in terms of control.

#### 9.4.1 DSP Features

The M Series amplifier HDSP is based on the DSP-D board platform and the Analog Device ADAU 1701.

The DSP-D board's flexible design caters a wide range of users: from the speaker manufacturer to the end user of rack amplifiers. The DSP-D provides both a completely programmable DSP to the experienced user as well as a complete tool with remote control for the end user. The ADAU 1701 device is a fixed point DSP

with 28-bit resolution for the internal path and 56-bit for internal processing. The board also provides full remote control through Armonía Pro Audio Suite.

The M Series DSP is modular for any channel pair, meaning, for example, that on a MxxD one module is available for channels 1 and 2 while on a MxxQ there are two modules available: one for channels 1 and 2 and another for channels 3 and 4. Keep in mind that the modules are physically separated, therefore input or output from different modules can't be mixed together.

#### 9.4.2 Input routing selection and internal signal route

Due to the internal amplifier structure, it is impossible to mix signals from non adjacent channels: for example, channel 1 and 4 cannot be mixed together but only channels 1-2 and channels 3-4 (on MxxQ models) can. The following configurations are possible for any channel pair:

- ▶ 1 input – 2 outputs
- ▶ 2 inputs – 2 outputs
- ▶ 2 mixed inputs – 2 outputs

#### 9.4.3 Input section

The input section allows system operation to improve sound for a specific zone, group of speakers, room, etc. The input section provides an input eq for any input channel with the following features:

- ▶ 5 biquad filters, any filter can become PEQ, shelving hi-lo pass, all pass
- ▶ Delay: up to 170 ms for 2 in/2 out and up to 340 ms for 1 in/2 out configurations
- ▶ Gain between -40 dB and 6 dB
- ▶ Mute
- ▶ Reverse polarity

#### 9.4.4 Output section

The output section allows multiway cabinet equalization and protection. The output section comprises an output eq and a limiter (peak and RMS) for each channel.

- ▶ Eq feature:
  - ▷ 12 biquad filters, any filter can become PEQ, shelving hi-lo pass, all pass. The crossover functions are obtained using one to four biquad filters for each crossover.
  - ▷ Delay of 10 ms
  - ▷ Gain between -40 dB and 6 dB
  - ▷ Mute
  - ▷ Reverse polarity
- ▶ Peak limiter feature:
  - ▷ Threshold, 20 – 135 V. With 1 V steps
  - ▷ Hold time, 0 – 2 sec. With 1 ms steps
  - ▷ Release time, 0 – 2 sec. With 1 ms steps
- ▶ RMS limiter feature:
  - ▷ Threshold, 13 – 312 W @ 8 Ω. With 1 W steps
  - ▷ Attack time, 2 – 4500 ms. With 1 ms steps
  - ▷ Hold time, 0 – 1 sec. With 1 ms steps
  - ▷ Release time, 4 – 4500 ms. With 1 ms steps
  - ▷ Two biquad filters for frequency shaping. Frequency

shaping is a function obtained by pre and post limiter eq. The same eq (with opposite gain) is applied before and after the limiter.

- ▶ Damping control:
  - ▷ Impedance correction between -2 Ω to +2 Ω with 0.1 Ω steps.

### 9.5 Internal processing layout

The following two layouts are available for each module (and its associated channel pair):

- ▶ 1 In / 2 out basic layout
- ▶ 2 In / 2 out basic layout with mono mix capabilities.

Due to the internal structure of the DSP, in order to optimize performance, two different binary presets for 1 input / 2 output configurations and for 2 input / 2 output configurations must be used. Be aware that any change in the binary preset causes an audio interruption while the M Series microprocessor loads the preset data into the DSP. This means that a change in configuration (e.g. going from 1 input to 2 inputs) or reloading a preset from the internal memory results in an audio interruption.

**NOTE:** The following information is valid for any single DSP module (2 channels). Devices with 4 channels are formed by 2 completely independent modules.

#### 9.5.1 Input routing

The two following configurations are available:

- ▶ 1 In / 2 out, the input is routed from channel 1.
- ▶ 2 In / 2 out, the input is routed from channel 1 and channel 2. It is possible to mix the two signals together; the mono mix function sums the two sources and halves their summed level.

#### 9.5.2 Input section

The input section is formed by the input eq alone, one for each channel of the loaded layout. For example, in the 1 input / 2 output module layout there is only 1 input eq for both output channels. Every input eq has 5 biquadratic filters which can be chosen and assigned from the set of standard IIR filters.

#### 9.5.3 Output section

Every module provides each channel with a set of 12 biquadratic filters and a complete set of limiters for protection purposes:

- ▶ Output eq: 12 biquad filters can be chosen for shaping (PEQ, shelving, etc) but these are shared between the crossovers. Each crossover can consume 1 to 4 biquad filters, depending on the crossover slope. [TABLE 2](#) and [TABLE 3](#) illustrate a number of crossover configurations. Mixed crossover configurations are possible (e.g. HP 12 dB/oct, LP 24 dB/oct).
- ▶ Peak limiter for every output.
- ▶ RMS limiter for every output.
- ▶ Frequency shaping.
- ▶ Damping control for every output

First crossover	Slope 6/12 dB/oct	Slope 18/24 dB/oct	Slope 30/36 dB/oct	Slope 40/48 dB/oct
Free biQuad filters remaining	11	10	9	8

TABLE 2: First crossover filters.

Second crossover	Slope 6/12 dB/oct	Slope 18/24 dB/oct	Slope 30/36 dB/oct	Slope 40/48 dB/oct
Free biQuad filters remaining	10	8	6	4

TABLE 3: Second crossover filters.

## 9.6 Locking

The locking mechanism allows to lock macro property values based on the functional sub section and on the channel base of the device; the lockable sub sections are:

- ▶ Input routing:
  - ▷ Mono mix
  - ▷ Input Section:
  - ▷ Equalizer
- ▶ Output Section:
  - ▷ Equalizer
  - ▷ RMS Limiter
  - ▷ Peak Limiter
  - ▷ Damping Control

Every channel subsection is independently lockable.

## 9.7 On/Off

The on/off function is available when an external voltage is supplied. Please refer to [Section 9.3](#) for further information.

## 9.8 Preset Management

The DSP allows to manage up to 4 presets per module and its associated channel pair. Each preset contains information on the following:

- ▶ Input routing
- ▶ Input Section
- ▶ Output Section
- ▶ Properties locking

The preset is handled by the client as a file with the .preset extension.

These presets can be selected via a preset selection button on the rear panel of the amp. There is one button for each DSP module. The manual preset selection function is disabled if the amplifier is remotely controlled by any client.

Amplifiers in the M Series are shipped with 4 default factory presets: positions one and two store a 2 in / 2 out routing preset each with an input delay of 170 ms. Positions three and four store a 1 in / 2 out preset with 340 ms input delay each.

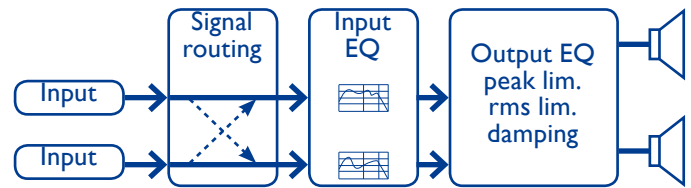

FIGURE 15: DSP internal layout.

**WARNING!** Selecting a preset with a rear button or via remote control will interrupt the audio stream for some seconds.

**WARNING!** Store the modified preset before turning the unit off or all changes will be lost.

**NOTE:** Selecting presets with the rear button is enabled only if remote control is NOT active.

## 10 Remote control

The M Series HDSP+ETH boards allow full amplifier remote control with Powersoft's software client Armonía Pro Audio Suite. Other third party clients are also available.

Armonía Pro Audio Suite is a software environment entirely developed in-house by Powersoft featuring full end user remote control of Powersoft's amplifiers and audio signal processing. The intuitive interface provides reliable information and real time control of all DSP functions. Refer to the Armonía manual for installation and configuration of the client software.

### 10.1 Networking

M Series HDSP+ETH amplifiers come with one rear RJ45 port for remote device communication, using the IP layer and the UDP protocol. Factory default settings are DHCP/AutoIP, but a fixed IP policy can also be adopted.

#### 10.1.1 Discovery device

In order to start remote operation on the device connected to your network, it must be discovered and imported into the Armonía workspace.

It may happen that a static IP in a different subnet with respect to Armonía has been assigned to your M Series amplifier (i.e. 10.0.x.y versus 169.254.x.y): if this is the case Armonía does not recognize the amplifier. You have to reset the IP configuration of your M Series amplifier: see Annex I for the right procedure.



#### 10.1.2 DHCP

When the data cable is connected the amplifier begins DHCP handshaking. If a DHCP server is present on the network, the unit is ready to be remotely controlled.

### 10.1.3 AUTOIP

Every device tries to set up network communication when the data cable is plugged in and connected to another device (PC, switch, etc.). If a DHCP server is not active in the device network the unit initiates a stateless address auto-configuration. It self assigns a link-local address of the type 169.254.x.y with a subnet mask 255.255.0.0. Please make sure that your PC is in the same subnet of the unit. Modern operating systems provide Zeroconf features for network auto-configuration.

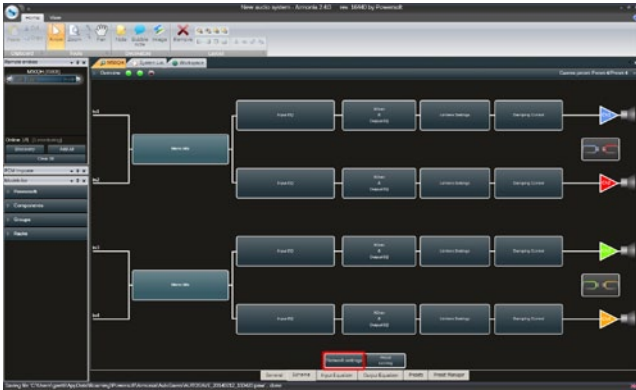

FIGURE 16: Push on the Network setting button.

### 10.1.4 Static IP

M Series devices can be set up with a static IP (or any other IP policy) with the Armonía control software. In order to set up the IP address please follow these steps.

1. Connect the device in a network with or without DHCP (ref. [Section 10.1.2](#)).

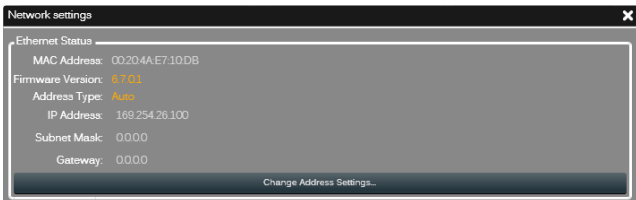

FIGURE 17: Select the static IP policy.

2. Discover the device and import it in the workspace (ref. [Section 10.1.1](#) or refer to the Armonía user guide).
3. Go to the device scheme tab and select the Network settings button.
4. Select the Static addressing mode from the combo box.

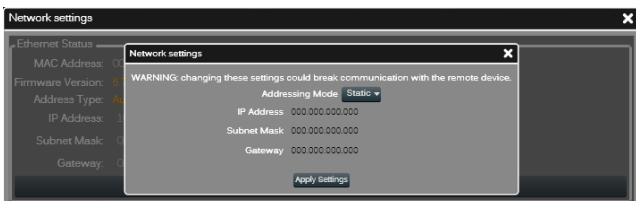

FIGURE 18: Fill in the IP, subnet, and net mask.

5. Insert the desired IP Address and network mask. Specifying the gateway is necessary only in complex LANs.
6. Click apply settings button.

**WARNING!** The device is reachable only from PCs in the same subnet mask, if this information is lost you will need to re-init the network device with a third-party software.

When done, the device network will restart automatically. The device will reconnect in approximately 15 seconds.

### 10.1.5 Revert from static IP

If for any reason re-programming the IP address or the IP policy of your unit should be necessary, follow the instructions in the previous chapter and make a different selection when assigning the IP. For example, should you need to revert the device to the automatic (DHCP, Zeroconf) IP settings, please follow these steps. Connect the device in a network with or without DHCP (ref. [Section 10.1.1](#)).

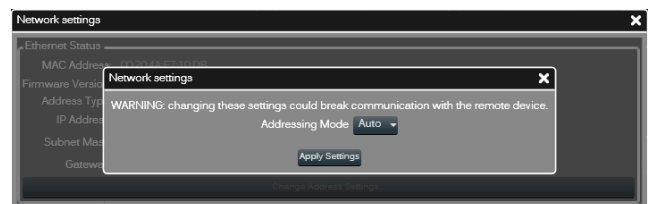

FIGURE 19: Select Auto addressing.

1. Discover the device and import in the workspace (ref. [Section 10.1.2](#) or refer to the Armonía user guide). Device and PC must use the same subnet. If you are not able to reconnect the device please refer to "[Annex A: IP management and recovery](#)".
2. Go to the device scheme tab and select the Network settings button.
3. Select the Auto addressing mode from the combo box.
4. Click apply settings button.

When done, the device network will restart automatically. The device will reconnect in approximately 15 seconds.

## 10.2 Setup device

There are two ways to configure the device, based on your needs and on the availability of the real device. The main difference is that you can either work with virtual devices before going online and then send the setup to the units remotely or you can operate on the physical unit directly.

### 10.2.1 Virtual device

If for some reason the devices are not available, configuration must be carried out via virtual devices or a system of virtual devices.

1. Select the device from the models window
2. Drag and drop in the Workspace
3. If you already have a device preset (.pam) you can import it by right clicking on the device (ref. [FIGURE 20](#)).
4. You can modify any DSP value following the instructions [Section 10.8](#).

At this point you can save and load the system file (.paw) at a later time. Please refer to the Armonia documentation. If the devices are ready for remote control you can associate the virtual device to the real device. To do so, please follow the instructions in the next section.

### 10.2.2 Configure layout

Virtual devices allow the use to select the processing layout for any single DSP module. Select the desired layout in the preset tab of any virtual device (ref. [FIGURE 22](#)).

### 10.2.3 Real device

Working on the real device remotely is also possible. In this case all changes made to a device are immediately audible. In order to work on a real device:

1. Connect the device and discover the connected units (ref. [Section 10.1](#)).
2. Drag the remote device into the workspace onto the virtual device (ref. [FIGURE 22](#)).
3. If the internal device setup is different you'll be prompted to select the realignment direction. By selecting yes the device setup is transmitted from the virtual device to the real device. By selecting no the device setup is transmitted from the real device to the virtual one.

**WARNING!** By answering “yes” to the realignment question, the M Series device loses data on the selected preset slot.

It is now possible to operate on the device.

**WARNING!** Remember that turning off or disconnecting the power plug without saving changes on any internal memory slot leads to data loss. Before turning off, save the data on any internal slot or export to a .pam file.

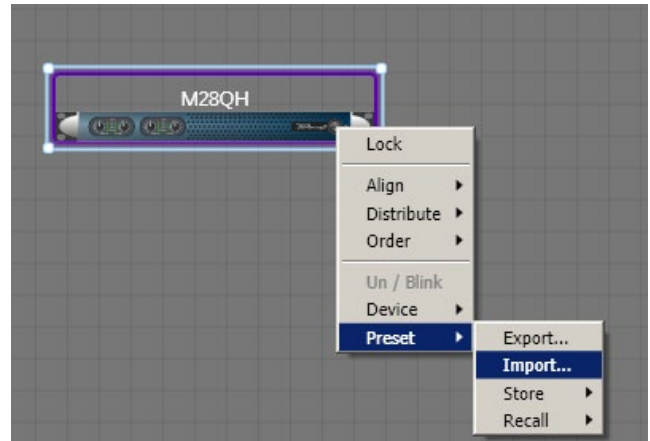

FIGURE 20: Left click to select (the blue rectangle appears) and right click for import.

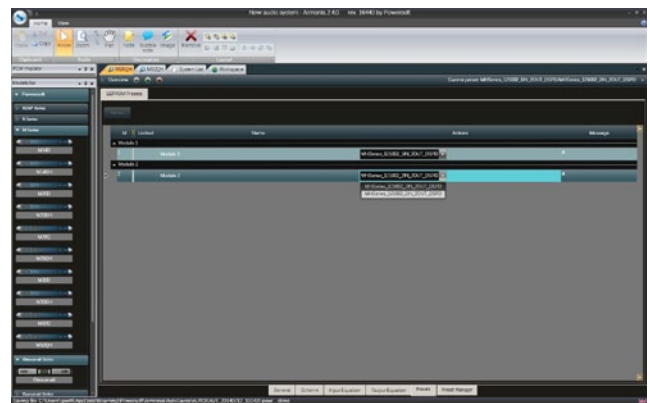

FIGURE 21: Select the desired layout in the combo-box.

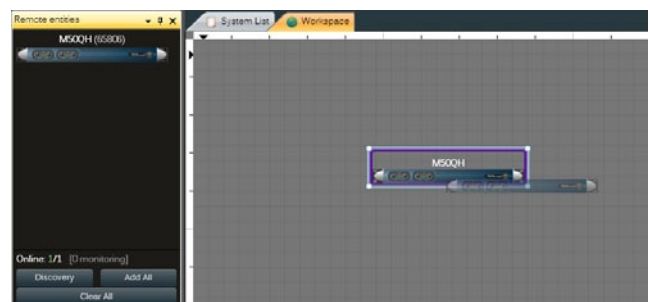

FIGURE 22: Drop the discovered device on the virtual device; when the arrow appears, release the left mouse button.



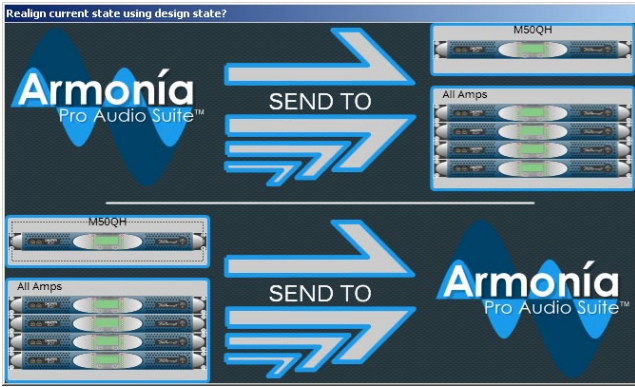

FIGURE 23: Realign window, asking for synchronization.

### 10.3 File operations

There are several import/export possibilities from/to files on a M Series unit. This section contains an explanation of all possible cases.

**WARNING!** Due to the internal structure of the device, some of these file operations can cause a temporary interruption of audio.

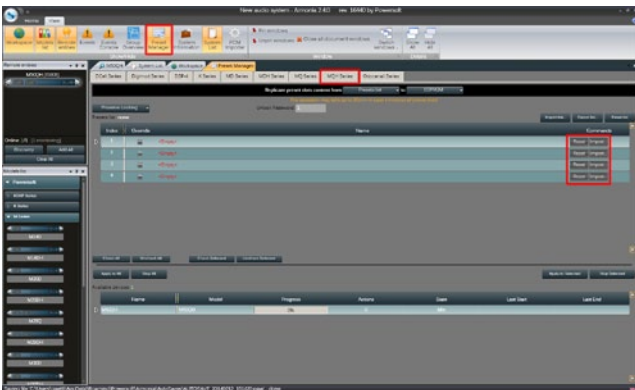

FIGURE 24: Preset management.

#### 10.3.1 Binary preset file .preset

Handling of the internal binary preset of an M Series DSP module is possible in the preset tab of the device.

**EXPORT:** export the actual preset slot to a .preset file.

**WARNING!** If the actual playing preset wasn't saved before export, the exported binary will be the last stored binary and not the current playing preset.

**IMPORT:** save a .preset file on the selected slot and recall that slot.

**WARNING!** This leads to a couple of seconds interruption of the audio stream.

**WARNING!** The data contained in a .preset file irreversibly modifies a preset slot and its internal layout.

### 10.4 Input/output curves .icp, .ocp

From the input or output tab of an M Series device, import/export of the current equalization curve is a straightforward procedure.

**WARNING!** All changes will be lost if the preset is NOT stored on board before unplugging the unit from the mains.

### 10.5 Channel preset .chp

Import/export of the current playing processing from/to a file is possible by starting from the device's layout.

**WARNING!** All changes will be lost if the preset is NOT stored on board before unplugging the unit from the mains.

**NOTE:** Importing channel preset files doesn't modify the internal structure of a device. For example, a channel exported from a 1 in / 2 out configuration doesn't affect the internal structure when imported in 2 in / 2 out processing layout.

**NOTE:** In the 1 in / 2 out configuration, the input eq is exported (or applied) to both input eq's. For example, exporting 1 in / 2 out configurations exports the unique input eq to both channels.

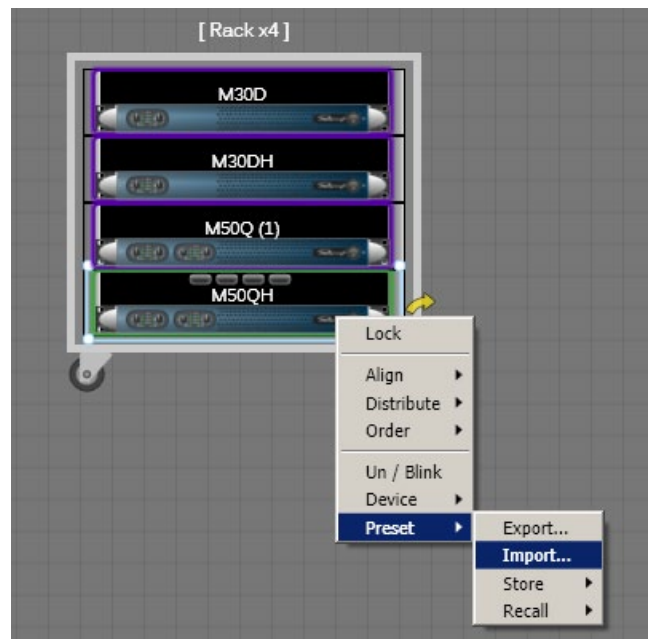

FIGURE 25: The .pam import/export operation from the workspace. Note the blue rectangle on the selected device.

### 10.6 Device preset file .pam

The preset file allows to import/export entire dumps of the device. An exported .pam file allows to completely replicate the DSP process on another device. In order to import/export a .pam file:

- ▶ Select the device (a blue rectangle will appear)

- ▶ Right click on the selected device
- ▶ Click on import/export

When importing a .pam file you'll be prompted for a decision on the realignment policy to adopt.

By selecting yes, the device setup is transmitted from the virtual device to the real device. By selecting no, the device setup is transmitted from the real device to the virtual device.

**WARNING! Importing a .pam file leads to a short interruption of the audio stream.**

**WARNING! Importing a .pam file overwrites the current preset slot on the device. Any previous data on the slot will be erased.**



FIGURE 26: All possible channel operations are available by right clicking on the respective channel.

## 10.7 System File .paw

Saving or opening a system file permits the storage of the entire processing of the current device imported in the workspace. For more information on system configuration, please refer to the Armonía manual.

The save operation may be seen as a large .pam export of the entire device; on the other hand, opening a .paw file is equivalent to performing a large .pam import on multiple devices. The user will be prompted for multiple realignment decision on any de-synchronized devices.

If the question is answered with:

- ▶ **yes**, the device specified in the window will be aligned to the data in the .paw file;
- ▶ **yes to all**, all the devices will be aligned to the data in the .paw file;
- ▶ **no**, the device specified in the window will NOT be aligned to the data in the .paw file but the data will be reloaded from the device.
- ▶ **no to all**, all the devices will NOT be aligned to the data in the .paw file but the data will be reloaded from the devices.

**WARNING! During import or preset manager operations the save .paw function is disabled.**

## 10.8 DSP remote operations

**WARNING! Due to the internal structure of the system some of the following file operations can lead to a short audio interruption.**

**WARNING! All changes will be lost if the preset is NOT stored on board before unplugging the unit from the mains.**

### 10.8.1 Routing

The input routing is based on the processing layout used: the 1 in / 2 out configuration, for example, allows input on odd channels only. On the other hand, the 2 in / 2 out configuration allows input on every channel. In this configuration, a mono mix from both channels is also allowed: the two channels are added together and their sum divided by two to normalize the resulting level. Available configurations are listed in TABLE 4 et le TABLE 5.

Module 0 configuration	Input Module 0	Output Module 0
1 In / 2 Out	Ch1	Ch1/Ch2
2 In / 2 Out	Ch1/Ch2	Ch1/Ch2

TABLE 4: MxxD amplifiers routing.

Module 0 configuration	Input Module 0	Output Module 0
1 In / 2 Out	Ch1	Ch1/Ch2
2 In / 2 Out	Ch1/Ch2	Ch1/Ch2

Module 1 configuration	Input Module 1	Output Module 1
1 In / 2 Out	Ch3	Ch3/Ch4
2 In / 2 Out	Ch3/Ch4	Ch3/Ch4

TABLE 5: MxxQ amplifiers routing.

### 10.8.2 Input eq

The input eq is intended for system operations. The input eq provides a range of biquad filters that can act as any generic IIR filter. From the input eq page, the frequency response of each channel can be adjusted in several ways. Discrete time delays can also be inserted. The presence of every input eq used in the device layout is reported on the tabbed channel on the bottom left hand side of the screen. The frequency response curves, together with other View items, are color coded: blue for channel 1, red for channel 2, green for channel 3, orange for channel 4. Every channel allows regulation of filters, mute, gain, delay and polarity. The frequency response (and/or phase response) curve displayed is always obtained as the combined response of all currently active filters.



FIGURE 27: Input EQ.

### 10.8.3 Output eq

This page's general appearance is similar to that of the Input Equalizer page, but presents several important differences. The Output Eq. curve the amplifier employs is meant to be created from the speaker manufacturer's data for the particular loudspeaker cabinets or arrays the amplifier will be driving. It provides a range biquad filter that can act as crossover or generic IIR filter. From this page, the frequency response of each channel can be adjusted in several ways. Discrete time delays can also be inserted. The presence of every output eq. present in the device layout is reported on the tabbed channel on the bottom left hand side of the screen. The frequency response curves, together with other View items, are color coded: blue for channel 1, red for channel 2, green for channel 3, orange for channel 4. Every channel allows regulation of filters, mute, gain, delay and polarity. The displayed frequency response (and/or phase response) curve is always obtained as the combined response of all currently active filters.



FIGURE 30: Output EQ.

### 10.8.4 Limiters

The function of the limiters is to protect voice coils from burning out due to excess power being delivered over an extended period of time or from excessively large signal peaks by limiting the maximum output voltage of the amplifier. The limiter window is accessible by clicking on the limiter block in the device layout view. Every channel limiter is color coded: blue for channel 1, red for channel 2, green for channel 3, orange for channel 4.

### 10.8.5 RMS limiter

Electromechanical transducers are highly inefficient; as such they transform a significant amount of input power into heat. The function of the RMS limiter is to protect the voice coils of speaker drivers from burning out due to excess power being delivered over an extended period of time. The RMS limiter is set by selecting a desired maximum power value but acts by limiting output voltage; by applying Ohm's law with a fixed reference  $8 \Omega$  load, the output voltage level corresponding to the desired maximum output power value is calculated as the square root of power times the load resistance ( $8 \Omega$ ). It is possible to set the values of:

- ▶ *Threshold* in watts, with respect to an  $8 \Omega$  load.
- ▶ *Attack time* is the time between the moment the output voltage exceeds the threshold and the moment of the onset of the limiting action.



FIGURE 28: The limiters dialog window.

- ▶ *Hold time* is the length of time during which the limiting action is maintained before the gain returns to normal levels because the output voltage drops below the threshold level.
- ▶ *Release time* is the length of time over which the limiting action is reduced and the gain is returned to normal following the drop of the output voltage below the threshold level.

### 10.8.6 Peak limiter

The function of the peak limiter is to protect voice coils from excessively large signal peaks by limiting the maximum output voltage of the amplifier. It's possible to set the values of:

- ▶ *Threshold* in volts, is the amplifier max output voltage level corresponding to the maximum displacement of the speaker diaphragm.
- ▶ *Hold time* is the time over which the limiting action is maintained before the gain level is returned to normal after the output voltage drops below the threshold.
- ▶ *Release time* is the length of time over which the limiting action is reduced and the gain is returned to normal following the drop of the output voltage below the threshold level.

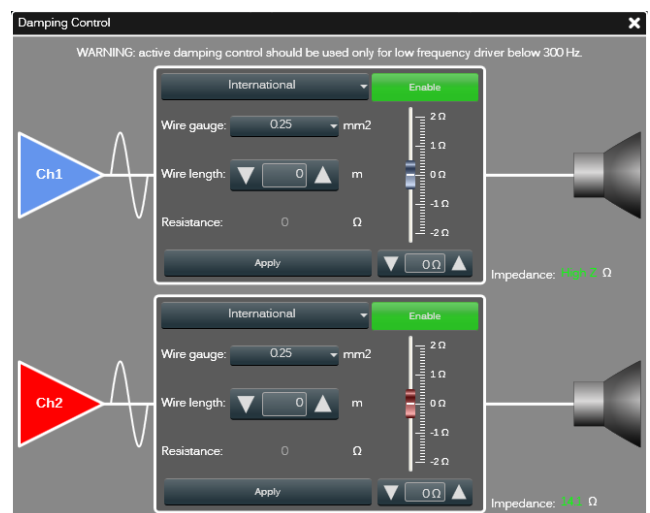

FIGURE 29: The damping control window.

### 10.14.1 Damping factor correction

The effect of cable resistance on a high power amplifier performance becomes significant at low frequencies, as the cable resistance can affect the output stage damping factor. Powersoft Damping Control is a proprietary algorithm which compensates for cable resistance. The user can enter cable parameters and the algorithm calculates and applies the appropriate correction. A tool to calculate the cable resistance is provided.

Damping factor correction can also be used to fine tune low end nuances: a negative resistance leads to a punched bass while a positive resistance leads to a tailed bass.

The following values can be set by the user:

- ▶ *Enable*: enables the correction algorithm.
- ▶ *Resistance compensation*: set the negative or positive resistance value added to the output circuitry.

The cable resistance tool allows to set:

- ▶ *Cable dimensions*: enter the gauge of the wire used in the speaker cable and the cable length into the Wire gauge dropdown list and the Wire length spinbox respectively. The upper drop-down list allows to choose between metric (international) and imperial units. The range of imperial wire gauges is 6 AWG to 23 AWG, and of metric wire gauges 0.25 mm<sup>2</sup> to 10 mm<sup>2</sup>. Maximum cable lengths are correspondingly 3280 ft or 1000 m.
- ▶ *Resistance compensation*: clicking Apply sets the cable resistance value calculated as the correction factor. The fader and its spinbox assume this value. However, the user can manually modify this calculated nominal value to obtain, for example, an enhanced LF response.

## 10.9 Locking

The locking mechanism allows the user to prevent changes to a whole preset or a part of a preset. The locking interface is divided in DSP module(s) and macro processing. Every module needs to be locked separately; the lock status is preserved with the import/export from/to file and copy/paste operations. In order to lock/unlock an entire module or parts of a module:

1. Access the locking interface.
2. If the module you want to modify is already locked, you need to insert the unlocking password for that module.
3. In order to lock the module with the selected layout, insert the locking password and press the button Apply.

A number of operations are allowed here. Please refer to for an explanation of the various functions and symbols.

### 10.10 On board preset operations

The preset tab of all M Series devices allows handling of the internal binary preset of an M Series DSP module.

**SAVE**: allows saving of the current DSP processing on the selected preset slot.

**LOAD**: recalls the selected preset slot.

**WARNING!** (re)Loading a preset causes a couple of seconds of interruption of the audio stream.

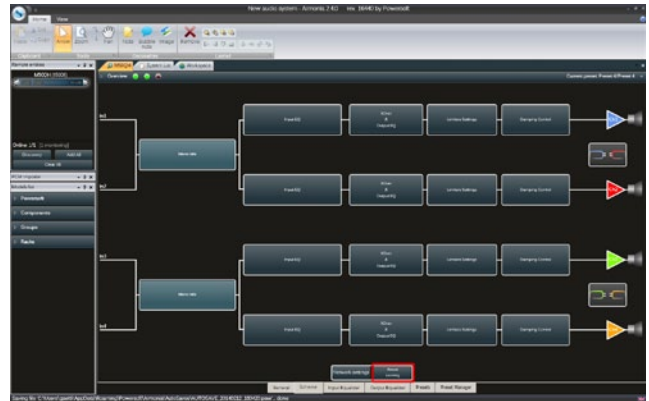

FIGURE 31: Click on the preset locking button in the layout tab of the device.

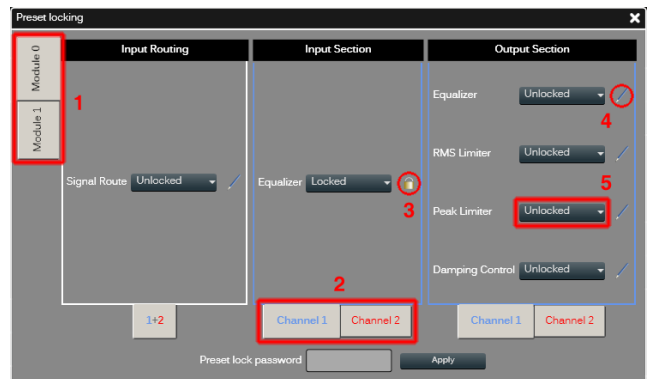

FIGURE 32: Functions and symbols in the preset locking window:  
 1. Select module; 2. Select channel for the macro property.  
 3. A padlock indicates a locked property; 4. A pencil indicates a writable property; 5. The combo box allows to change the single macro property.

### 10.11 Copy and paste operations

Any paste operation does not affect the DSP binary and its corresponding structure; therefore, applying data with the paste command does not lead to audio interruption.

**WARNING!** Any data pasted into a device needs to be saved in a preset slot, otherwise any turn off/on cycle leads to data loss.

### 10.12 Input/output eq curves

In order to copy/paste an eq curve, copy the source curve with the dedicated copy function and paste to the destination eq. with the dedicated paste function.

**WARNING!** All changes will be lost if the preset is NOT stored on board before unplugging the unit from the mains.

### 10.13 Channels

Copy and paste of the current playing processing setup from/to the clipboard is possible from the device layout.

**WARNING! All changes will be lost if the preset is NOT stored on board before unplugging the unit from the mains.**

**NOTE:** pasting a channel preset file doesn't modify the internal structure of a device. For example, a channel copied from a 1 in / 2 out configuration doesn't affect the internal structure when pasted in a 2 in /2 out processing layout.

**NOTE:** in the 1 in / 2 out configuration the input eq is copied (or applied) to both input eq's. For example, copying the configuration of both channels (1 in /2 out configuration) leads to pasting the unique input eq to both channels.

### 10.14 Workspace

The copy/paste function from an M Series device to another M Series device is limited to:

The same family device (e.g. source M20D, target M20D).

The same internal processing layout (e.g. source IIN/2OUT, target IIN/2OUT).

**WARNING! All changes will be lost if the preset is NOT stored on board before unplugging the unit from the mains.**

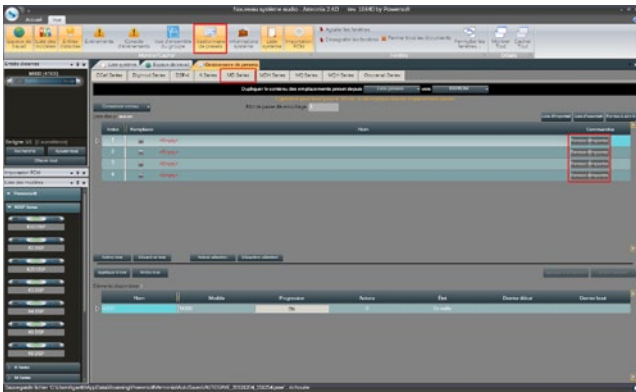

FIGURE 34: Presets handling



FIGURE 33: The output eq, there are 4 possible alternatives to handle the curve.

## II Protection

In order to protect your device and your speakers from accidental damage, M Series amplifiers include an extensive automatic protection system. In the following sections, potentially dangerous scenarios and the amplifiers' corresponding protective response are explained in detail.

### 11.1 Turn on/Turn off muting

Class D amplifiers may cause severe speaker damage at power up due to the high voltage levels at the output stage. In order to avoid this, the outputs are muted for less than 2 seconds (less than 5 seconds for DSP models) after turn on. Similarly, turning off the amplifier can cause the same problem: outputs are muted immediately at turn off.

### 11.2 Short circuit protection

Short circuits or very low impedance loads may destroy the output stage of any amplifier. In order to protect the amplifier from the dangerously high current surges arising from accidental output short circuits or low impedance loads, all M series amps block channel activity when the current drawn from the load rises above a set value. The channel is muted for 2 seconds after which the amplifier will unmute the channel and check whether the current draw is still over the safety threshold. Should this be the case, the amplifier will mute the channels for another 2 seconds and the procedure will reiterate. The red "CLIP" LED will be turned off only when the output current draw will have returned within safe limits.

### 11.3 Thermal protection

All Powersoft amplifiers have variable speed fans to assist cooling. If for some reason the cooling system can't dissipate the produced heat correctly, a thermal protection system is automatically activated to avoid permanent damages. Every channel pair has a temperature sensor on the output stage heat sink. Two different protection strategies are implemented depending on the severity of the overheating. In order to protect internal components, the amplifier may automatically reduce output power until the internal temperature returns to safe levels.

### 11.4 Thermal warning

If the heat sink reaches a temperature of approximately 75°C, the front panel red "TEMP" LED corresponding to the overheated channel pair turns on to warn the user of a potentially dangerous thermal event. Output power is reduced to prevent damages to the output stage.

### 11.5 Thermal shutdown

If the heat sink temperature rises above 85°C, the thermal sensing circuitry will mute each power section of each compromised channel pair. Only after the heat sink has cooled down to below 75°C the channel pair will automatically unmute and the red "TEMP" LED will be turned off.

## 11.6 DC fault protection

In order to protect your speakers from mechanical damage caused by a DC signal coming from the amplifier's output, a DC detection circuit is placed between the amplifier's output stage and power supply. If a DC signal or excessive subsonic energy appears at a channel output an instantaneous protection circuit will mute the compromised channel pair. The red "CLIP" LED will turn on to signal that protective measures have been engaged.

## 11.7 Input/output protection

Interference protection is implemented in the M Series to limit out of band noise carried by the input lines. Disturbing frequencies can interact with the output stage, causing unpredictable amplifier behavior. A filtering system is used to stop infrasonic and VHF signals from entering the signal path.

## 12 User Maintenance

---

### 12.1 Cleaning

Before attempting to clean any part of the amplifier, first disconnect the AC main source. Use a soft cloth and mild non-abrasive solution to clean the faceplate and chassis.

WARNING! Never let any liquid reach the internal parts of the amplifier.

### 12.2 Service

There are no user-serviceable parts in your amplifier. Refer servicing to qualified technical personnel. In addition to having an in-house service department, Powersoft supports a network of authorized service centers. If your amplifier needs repair contact your Powersoft dealer (or distributor). You can also contact the Powersoft Technical Service department to obtain the location of the nearest authorized service center.

### 12.3 Dust Removal

In dusty environments, the front side air filters clog with dust after prolonged use. The dust gathered in the filters will interfere with cooling. You may use compressed air to remove the dust from filters. To remove air filters please refer to the front panel removal procedure (see [Section 8.1](#)). Air filter cleaning should be scheduled according to the dust levels in the amplifier's operating environment.

## 13 Warranty

---

### 13.1 Product warranty

Powersoft guarantees its manufactured products to be free from defective components and factory workmanship for a period of 48 (forty eight) months, starting from the date of purchase printed on Powersoft's (or any of its Authorized Dealer's) invoice to the end

customer. All warranty repairs and retrofits must be performed at Powersoft facilities or at an Authorized Service Center at no cost for the purchaser. Warranty exclusion: Powersoft's warranty does not cover product malfunctioning or failure caused by: misuse, abuse, repair work or alterations performed by non-authorized personnel, incorrect connections, exposure to harsh weather conditions, mechanical damages (including shipping accidents), and normal wear and tear. Powersoft will perform warranty services provided that the product is not damaged during transportation.

### 13.2 Return of Goods

Goods can be returned to Powersoft only after they have been granted a Return Merchandise Authorization (RMA) number to be attached to the external packaging. Powersoft (or its Authorized Service Center) has the right to refuse any returned good without a RMA number.

### 13.3 Repair or replacement

Powersoft reserves the right to repair or replace any defective goods covered by product warranty at its sole discretion and as it deems best.

### 13.4 Cost and responsibility of transport

The purchaser (or end user/customer) is solely responsible for all transportation costs and risks associated with sending warranty covered goods to Powersoft or its Authorized Service Center. Powersoft will assume full responsibility and cover all costs incurred to send the goods back to the purchaser (or end user/customer).

## 14 Assistance

---

Even though most product malfunctioning can be solved at your premises through Powersoft Customer Care or your direct knowledge, occasionally, due the nature of the failure, it might be necessary to return defective products to Powersoft for repair. In the latter case, before shipping, you are kindly asked to follow step by step the procedure described below: Obtain the "Defect Report Form" by contacting our Customer Care Department via email: [service@Powersoft.it](mailto:service@Powersoft.it) or download the "Defect Report Form".

Fill out one "Defect Report form" for each returned item (the form is an editable tab guided document) and save as your name, amp model and serial Number (for example: `distributornamek10sn17345.doc`) providing all required information except the RMA code/s and send it to [service@powersoft.it](mailto:service@powersoft.it) for Powersoft approval.

In case of defect reports approved by the Powersoft Customer Service Representative you will receive an RMA authorization code (one RMA code for each returning device). Upon receiving the RMA code you must package the unit and attach the RMA code outside the pack, protected in a waterproof transparent envelope so it is clearly visible.

All returning items must be shipped to the following address:

Powersoft  
Via Enrico Conti, 13-15  
50018 Scandicci (FI) Italy

In case of shipment from countries NOT belonging to the European Community make sure you have also followed the instructions described in the document available for download at the TEMPORARY EXPORTATION / IMPORTATION PROCEDURE link at <http://www.Powersoft-audio.com/en/support/service.html>

Thank you for your understanding and cooperation and continued support as we work to improve our partnership.

## 15 M Series power rating

	Model name	Single-channel mode		Distributed lines		Mono-bridge mode
		4 Ω	8 Ω	70 V	100 V	8 Ω
2 channel amplifiers	M14D/M14D HDSP+ETH	700 W	360 W	—	—	1400 W
	M20D/M20D HDSP+ETH	1200 W	600 W	1200 W <sup>1</sup>	—	2400 W
	M30D/M30D HDSP+ETH	1500 W	900 W	1200 W <sup>2</sup>	1500 W <sup>3</sup>	3000 W
4 channel amplifiers	M28Q/M28Q HDSP+ETH	700 W	360 W	—	—	1400 W
	M50Q/M50Q HDSP+ETH	1250 W	750 W	1000 W <sup>2</sup>	1250 W <sup>3</sup>	2500 W

1 with an external high pass filter for non HDSP models and with an HDSP preset with a high pass filter and output voltage limiter for models with HDSP.

2 with an external high pass filter and output voltage limiter for non HDSP models and with an HDSP preset with a high pass filter and output voltage limiter for models with HDSP.

3 with an external high pass filter for non HDSP models and with an HDSP preset with a high pass filter for models with HDSP.

## 16 Output SpeakON connection polarities

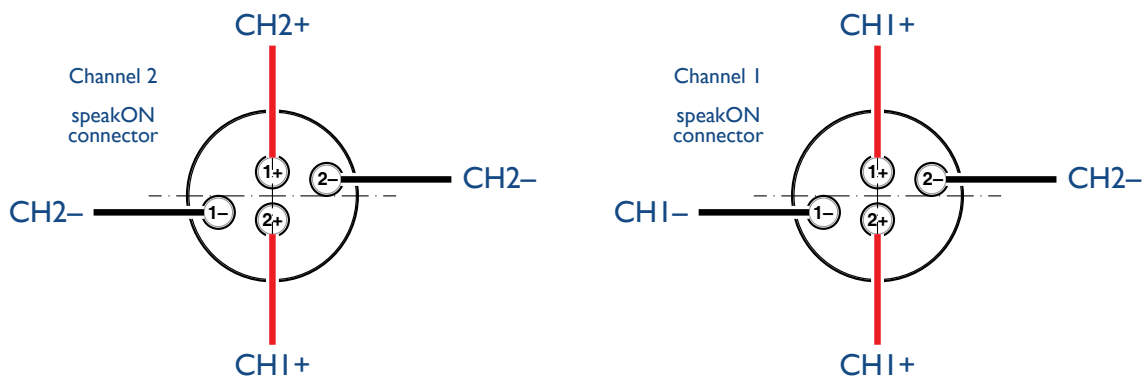

## 17 M Series load compatibility chart

Model	lo-Z loads	70 V distributed line	100 V distributed line
M14D	yes	no	no
M14D HDSP+ETH	yes	no	no
M20D	yes	yes with an external high pass filter	no
M20D HDSP+ETH	yes	yes with an HDSP preset with a high pass filter	no
M30D	yes	yes with an external high pass filter and peak limiter	yes with an external high pass filter
M30D HDSP+ETH	yes	yes with an HDSP preset with a high pass filter and an output voltage limiter	yes with an HDSP preset with a high pass filter
M28Q	yes	no	no
M28Q HDSP+ETH	yes	no	no
M50Q	yes	yes with an external high pass filter and peak limiter	yes with an external high pass filter
M50Q HDSP+ETH	yes	yes with a DSP preset with a high pass filter and an output voltage limiter	yes with a DSP preset with a high pass filter

# 18 M Series block diagram

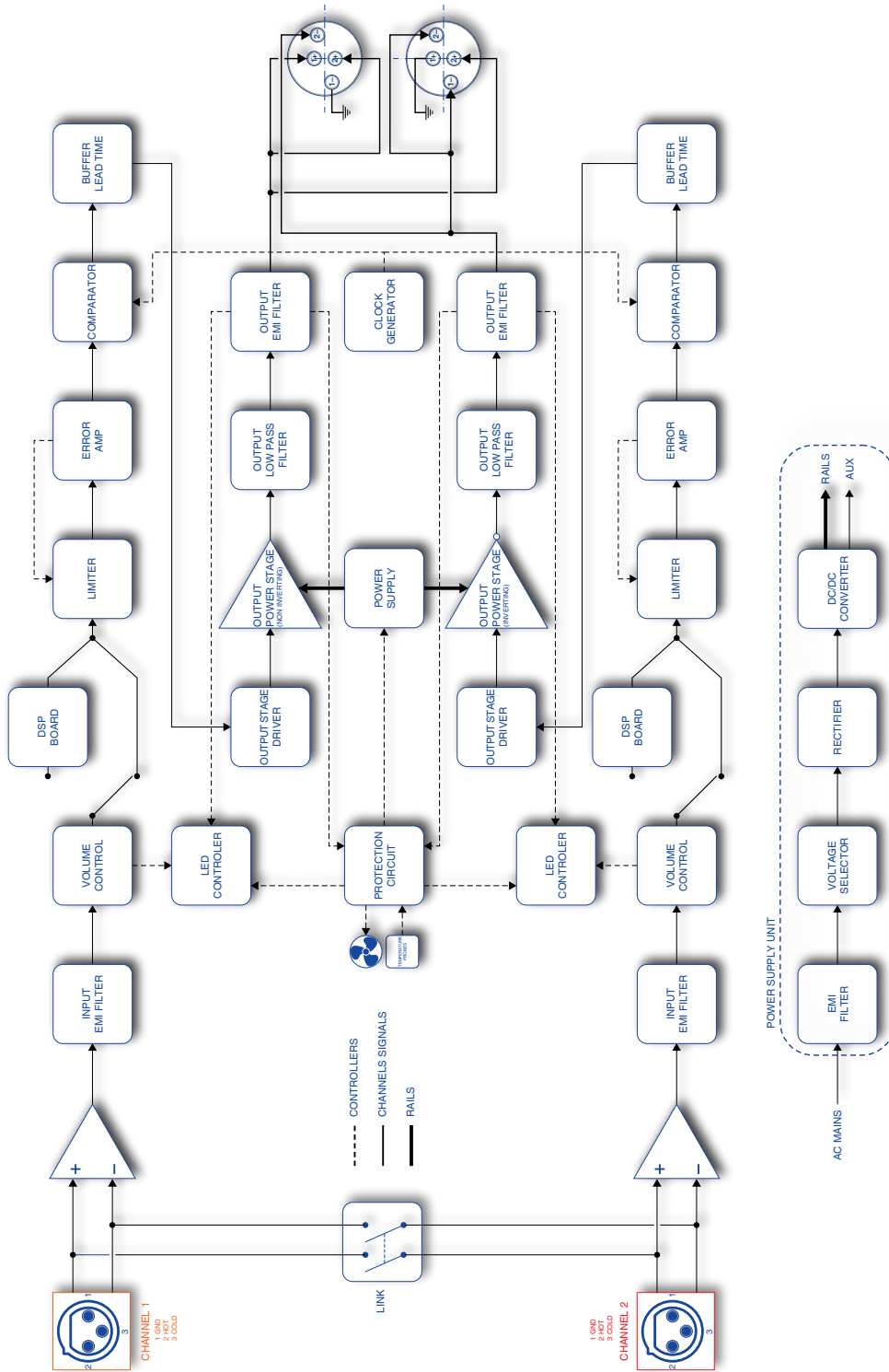



## 19 Specifications

### MI4D and MI4D HDSP+ETH

General	
Number of channels	2 mono, bridgable per channel pair
Max output power per channel*	single channel mode
	bridge mode
	4 Ω / Ch
	8 Ω / Ch
	8 Ω / Ch pair
	700 W
	360 W
	1400 W
Max output voltage	85 V <sub>peak</sub> / 65 A <sub>peak</sub>
	170 V <sub>peak</sub> / 65 A <sub>peak</sub>
AC Mains Power	
Power supply	Universal, regulated switch mode
Nominal power requirements	AC 100 V - 240 V (factory selection), 50/60 Hz
Operating range	AC 90 V - 264 V
Consumption / current draw	230 V
	115 V
Idle	39 W
	0.3 A
I/8 of max power @ 4 Ω	283 W
	1.9 A
	39 W
	238 W
I/4 of max power @ 4 Ω	538 W
	3.5 A
	538 W
	7 A
Thermal	
Environmental operating temperature	0° - 45° C / 32° - 113° F
Thermal dissipation	Fan, variable speed, temperature controlled front to rear airflow
	230 V
Idle	133 BTU/h
	33 kcal/h
I/8 of max power @ 4 Ω	368 BTU/h
	93 kcal/h
I/4 of max power @ 4 Ω	641 BTU/h
	162 kcal/h
Audio	
Gain	32 dB, 30 dB, 28 dB, 26 dB, 24 dB, 22 dB, 20 dB, 18 dB, 14 dB, 4 dB, -∞, user selectable
Frequency response	20 Hz - 20 kHz ±0.5 dB @ 1 W, 8 Ω
S/N ratio (amplifier section)	> 109 dB (20 Hz - 20 kHz, A weighted)
Crosstalk separation	>70 dB @ 1 kHz, 4 Ω
Input sensitivity @ 8 Ω	1.4 V <sub>rms</sub> / +5.14 dBu
Max input level	6 V <sub>rms</sub> / +17.8 dBu
Input impedance	10 kΩ balanced
THD+N / DIM100 IMD	< 0.02% (typically <0.005%) @ 4 Ω
Slew rate	40 V/μs @ 8 Ω input filter bypassed
Damping factor	> 5000 @ 100 Hz
DSP**	
A/D converter	CS5381, 2 channels, 24 bit / 48 kHz, 120 dB SNR
D/A converter	CS4398, 2 channels, 24 bit / 48 kHz, 120 dB SNR
Frequency response @ -3 dB	7 Hz - 22 kHz
THD	< 0.01% (20 Hz - 20 kHz)
Presets	Bank of 4 presets, management and upload via Armonia Pro Audio Suite™
Delay for time alignment	10 ms per output
Crossover filters	Butterworth, Linkwitz-Riley, Bessel, 6 dB/oct to 48 dB/oct
Output equalizer	up to 12 biquad fully parametric per channel: peaking, hi/lo shelving, hi/lo pass, band pass, band stop, all pass.
Input equalizer	up to 5 biquad filters (PEQ, shelving, band pass, band stop, all pass)
Limiters	Peak limiter, RMS limiter, frequency dependent RMS limiter
Damping control	< 120 Hz, range ± 2 Ω
System Delay	up to 170 ms for 2 IN/2 OUT or 340 ms for 1 IN/ 2 OUT
Front panel	
Indicators	1 LED bar per channel and 2 status LED
Controls	1 stepped level attenuator pot per channel; mains switch
Maintenance	Dust filter foam behind front panels
Rear panel	
Controls	1 x link switch, linking analog inputs 1 & 2
Input / Output connectors	2 x balanced Neutrik® XLR female
	2 x Neutrik® Speakon NL4MD, 2 x Neutrik® XLR male hardwired to the corresponding input
Network data port Ethernet**	1 x RJ45 with activity LED with 2 rotary address switches
DSP preset selection**	1 x Pushbutton (stepping through bank of 4 presets); 1 x 4 LED preset indicators
Aux voltage**	1 x 2-pin Phoenix type MC 1.5/2-ST-3.81
AC mains	IEC C13 16 A connector; AC mains cord with 3-pin plug 15 A for US, IEC Schuko 16 A for every other nation
Construction	
Dimensions	L x H x W: 483 mm x 44.5 mm x 379 mm / 19" x 1.8" x 14.9"
Weight	7.4 kg (16 lb)

\* EIAJ Test Standard, 1 kHz, 1% THD, all channels driven. \*\* HDSP+ETH version only.

## M20D and M20D HDSP+ETH

General					
Number of channels	2 mono, bridgable per channel pair				
Max output power per channel*	single channel mode				bridge mode
	4 Ω / Ch	8 Ω / Ch	70 V**	100 V**	8Ω / Ch pair
	1200 W	600 W	1200 W	—	2400 W
Max output voltage	116V <sub>peak</sub> / 65 A <sub>peak</sub>				232V <sub>peak</sub> / 65 A <sub>peak</sub>
AC Mains Power					
Power supply	Universal, regulated switch mode				
Nominal power requirements	AC 100 V - 240 V (factory selection), 50/60 Hz				
Operating range	AC 90 V - 264 V				
Consumption / current draw	230 V		115 V		
Energy save on	35 W	0.3 A	35 W	0.6 A	
Energy save off	371 W	2.54 A	371 W	3.8 A	
1/8 of max power @ 8 Ω	701 W	4.5 A	701 W	9 A	
Thermal					
Environmental operating temperature	0° - 45° C / 32° - 113° F				
Thermal dissipation	Fan, variable speed, temperature controlled front to rear airflow				
	230 V				
Idle	126 BTU/h		32 kcal/h		
1/8 of max power @ 4 Ω	529 BTU/h		133 kcal/h		
1/4 of max power @ 4 Ω	935 BTU/h		236 kcal/h		
Audio					
Gain	32 dB, 30 dB, 28 dB, 26 dB, 24 dB, 22 dB, 20 dB, 18 dB, 14 dB, 4 dB, -∞, user selectable				
Frequency response	20 Hz - 20 kHz ±0.5 dB @ 1 W, 8 Ω				
S/N ratio (amplifier section)	> 107 dB (20 Hz - 20 kHz, A weighted)				
Crosstalk separation	>70 dB @ 1 kHz, 4 Ω				
Input sensitivity @ 8 Ω	1.73 V <sub>rms</sub> / +7 dBu				
Max input level	6 V <sub>rms</sub> / +17.8 dBu				
Input impedance	10 kΩ balanced				
THD+N / DIM100 IMD	< 0.02% (typically <0.005%) @ 4 Ω				
Slew rate	40 V/μs @ 8 Ω input filter bypassed				
Damping factor	> 5000 @ 100 Hz				
DSP***					
A/D converter	CS5381, 2 channels, 24 bit / 48 kHz, 120 dB SNR				
D/A converter	CS4398, 2 channels, 24 bit / 48 kHz, 120 dB SNR				
Frequency response @ -3 dB	7 Hz - 22 kHz				
THD	< 0.01% (20 Hz - 20 kHz)				
Presets	Bank of 4 presets, management and upload via Armonia Pro Audio Suite™				
Delay for time alignment	10 ms per output				
Crossover filters	Butterworth, Linkwitz-Riley, Bessel, 6 dB/oct to 48 dB/oct				
Output equalizer	up to 12 biquad fully parametric per channel: peaking, hi/lo shelving, hi/lo pass, band pass, band stop, all pass.				
Input equalizer	up to 5 biquad filters (PEQ, shelving, band pass, band stop, all pass)				
Limiters	Peak limiter, RMS limiter, frequency dependent RMS limiter				
Damping control	< 120 Hz, range ± 2 Ω				
System Delay	up to 170 ms for 2 IN/2 OUT or 340 ms for 1 IN/ 2 OUT				
Front panel					
Indicators	1 LED bar per channel and 2 status LED				
Controls	1 stepped level attenuator pot per channel; mains switch				
Maintenance	Dust filter foam behind front panels				
Rear panel					
Controls	1 x link switch, linking analog inputs 1 & 2				
Input / Output connectors	2 x balanced Neutrik® XLR female 2 x Neutrik® Speakon NL4MD, 2 x Neutrik® XLR male hardwired to the corresponding input				
Network data port Ethernet***	1 x RJ45 with activity LED with 2 rotary address switches				
DSP preset selection***	1 x Pushbutton (stepping through bank of 4 presets); 1 x 4 LED preset indicators				
Aux voltage***	1 x 2-pin Phoenix type MC 1.5/2-ST-3.81				
AC mains	IEC C13 16 A connector; AC mains cord with 3-pin plug 15 A for US, IEC Schuko 16 A for every other nation				
Construction					
Dimensions	L x H x W: 483 mm x 44.5 mm x 379 mm / 19" x 1.8" x 14.9"				
Weight	7.4 kg (16 lb)				

\* EIAJ Test Standard, 1 kHz, 1% THD, all channels driven. \*\* DSP preset or external high-pass and voltage limiter required. \*\*\* HDSP+ETH version only.

## M30D and M30D HDSP+ETH

General					
Number of channels	2 mono, bridgable per channel pair				
Max output power per channel*	single channel mode				bridge mode
	4 $\Omega$ / Ch	8 $\Omega$ / Ch	70 V**	100 V**	8 $\Omega$ / Ch pair
	1500 W	900 W	1200 W	1500	3000 W
Max output voltage	135V <sub>peak</sub> / 65 A <sub>peak</sub>				270V <sub>peak</sub> / 65 A <sub>peak</sub>
AC Mains Power					
Power supply	Universal, regulated switch mode				
Nominal power requirements	AC 100 V - 240 V (factory selection), 50/60 Hz				
Operating range	AC 90 V - 264 V				
Consumption / current draw	230 V		115 V		
Energy save on	37 W	0.3 A	37 W	0.6 A	
Energy save off	530 W	2.54 A	530 W	3.8 A	
1/8 of max power @ 8 $\Omega$	1024 W	6.52 A	1024 W	13.04 A	
Thermal					
Environmental operating temperature	0° - 45° C / 32° - 113° F				
Thermal dissipation	Fan, variable speed, temperature controlled front to rear airflow				
	230 V				
Idle	126 BTU/h		32 kcal/h		
1/8 of max power @ 4 $\Omega$	529 BTU/h		133 kcal/h		
1/4 of max power @ 4 $\Omega$	935 BTU/h		236 kcal/h		
Audio					
Gain	32 dB, 30 dB, 28 dB, 26 dB, 24 dB, 22 dB, 20 dB, 18 dB, 14 dB, 4 dB, - $\infty$ , user selectable				
Frequency response	20 Hz - 20 kHz $\pm$ 0.5 dB @ 1 W, 8 $\Omega$				
S/N ratio (amplifier section)	> 110 dB (20 Hz - 20 kHz, A weighted)				
Crosstalk separation	>70 dB @ 1 kHz, 4 $\Omega$				
Input sensitivity @ 8 $\Omega$	2.13 V <sub>rms</sub> / +8.8 dBu				
Max input level	6 V <sub>rms</sub> / +17.8 dBu				
Input impedance	10 k $\Omega$ balanced				
THD+N / DIM100 IMD	< 0.02% (typically <0.005%) @ 4 $\Omega$				
Slew rate	40 V/ $\mu$ s @ 8 $\Omega$ input filter bypassed				
Damping factor	> 5000 @ 100 Hz				
DSP***					
A/D converter	CS5381, 2 channels, 24 bit / 48 kHz, 120 dB SNR				
D/A converter	CS4398, 2 channels, 24 bit / 48 kHz, 120 dB SNR				
Frequency response @ -3 dB	7 Hz - 22 kHz				
THD	< 0.01% (20 Hz - 20 kHz)				
Presets	Bank of 4 presets, management and upload via Armonia Pro Audio Suite™				
Delay for time alignment	10 ms per output				
Crossover filters	Butterworth, Linkwitz-Riley, Bessel, 6 dB/oct to 48 dB/oct				
Output equalizer	up to 12 biquad fully parametric per channel: peaking, hi/lo shelving, hi/lo pass, band pass, band stop, all pass.				
Input equalizer	up to 5 biquad filters (PEQ, shelving, band pass, band stop, all pass)				
Limiters	Peak limiter, RMS limiter, frequency dependent RMS limiter				
Damping control	< 120 Hz, range $\pm$ 2 $\Omega$				
System Delay	up to 170 ms for 2 IN/2 OUT or 340 ms for 1 IN/ 2 OUT				
Front panel					
Indicators	1 LED bar per channel and 2 status LED				
Controls	1 stepped level attenuator pot per channel; mains switch				
Maintenance	Dust filter foam behind front panels				
Rear panel					
Controls	1 x link switch, linking analog inputs 1 & 2				
Input / Output connectors	2 x balanced Neutrik® XLR female 2 x Neutrik® Speakon NL4MD, 2 x Neutrik® XLR male hardwired to the corresponding input				
Network data port Ethernet***	1 x RJ45 with activity LED with 2 rotary address switches				
DSP preset selection***	1 x Pushbutton (stepping through bank of 4 presets); 1 x 4 LED preset indicators				
Aux voltage***	1 x 2-pin Phoenix type MC 1.5/2-ST-3.81				
AC mains	IEC C13 16 A connector; AC mains cord with 3-pin plug 15 A for US, IEC Schuko 16 A for every other nation				
Construction					
Dimensions	L x H x W: 483 mm x 44.5 mm x 379 mm / 19" x 1.8" x 14.9"				
Weight	7.4 kg (16 lb)				

\* EIAJ Test Standard, 1 kHz, 1% THD, all channels driven. \*\* DSP preset or external high-pass and voltage limiter required. \*\*\* HDSP+ETH version only.

## M28Q and M28Q HDSP+ETH

Général			
Nombre de canaux	4 mono, bridgable per channel pair		
Puissance de sortie max par canal*	mode Simple canale		mode Ponté
	4 $\Omega$ / Canal	8 $\Omega$ / Canal	8 $\Omega$ / par paire de canaux
	700 W	360 W	1400 W
Tension de sortie max	85 V <sub>crête</sub> / 65 A <sub>crête</sub>		170 V <sub>crête</sub> / 65 A <sub>crête</sub>
AC Mains Power			
Power supply	Universal, regulated switch mode		
Nominal power requirements	AC 100 V - 240 V (factory selection), 50/60 Hz		
Operating range	AC 90 V - 264 V		
Consumption / current draw	230 V		115 V
Idle	62 W	0.51 A	64 W 0.6 A
1/8 of max power @ 4 $\Omega$	580 W	3.74 A	580 W 7.48 A
1/4 of max power @ 4 $\Omega$	1066 W	6.52 A	1066 W 13.04 A
Thermal			
Environmental operating temperature	0° - 45° C / 32° - 113° F		
Thermal dissipation	Fan, variable speed, temperature controlled front to rear airflow		
	230 V		
Idle	212 BTU/h		53 kcal/h
1/8 of max power @ 4 $\Omega$	785 BTU/h		198 kcal/h
1/4 of max power @ 4 $\Omega$	1249 BTU/h		315 kcal/h
Audio			
Gain	32 dB, 30 dB, 28 dB, 26 dB, 24 dB, 22 dB, 20 dB, 18 dB, 14 dB, 4 dB, - $\infty$ , user selectable		
Frequency response	20 Hz - 20 kHz $\pm$ 0.5 dB @ 1 W, 8 $\Omega$		
S/N ratio (amplifier section)	> 111 dB (20 Hz - 20 kHz, A weighted)		
Crosstalk separation	>70 dB @ 1 kHz, 4 $\Omega$		
Input sensitivity @ 8 $\Omega$	1.34 V <sub>rms</sub> / +4.7 dBu		
Max input level	6 V <sub>rms</sub> / +17.8 dBu		
Input impedance	10 k $\Omega$ balanced		
THD+N / DIM100 IMD	< 0.02% (typically <0.005%) @ 4 $\Omega$		
Slew rate	40 V/ $\mu$ s @ 8 $\Omega$ input filter bypassed		
Damping factor	> 5000 @ 100 Hz		
DSP**			
A/D converter	CS5381, 2 channels, 24 bit / 48 kHz, 120 dB SNR		
D/A converter	CS4398, 2 channels, 24 bit / 48 kHz, 120 dB SNR		
Frequency response @ -3 dB	7 Hz - 22 kHz		
THD	< 0.01% (20 Hz - 20 kHz)		
Presets	Bank of 4 presets, management and upload via Armonia Pro Audio Suite™		
Delay for time alignment	10 ms per output		
Crossover filters	Butterworth, Linkwitz-Riley, Bessel, 6 dB/oct to 48 dB/oct		
Output equalizer	up to 12 biquad fully parametric per channel: peaking, hi/lo shelving, hi/lo pass, band pass, band stop, all pass.		
Input equalizer	up to 5 biquad filters (PEQ, shelving, band pass, band stop, all pass)		
Limiters	Peak limiter, RMS limiter, frequency dependent RMS limiter		
Damping control	< 120 Hz, range $\pm$ 2 $\Omega$		
System Delay	up to 170 ms for 2 IN/2 OUT or 340 ms for 1 IN/ 2 OUT		
Front panel			
Indicators	1 LED bar per channel and 4 status LED		
Controls	1 stepped level attenuator pot per channel; mains switch		
Maintenance	Dust filter foam behind front panels		
Rear panel			
Controls	2 x link switch, linking analog inputs 1&2 and 3&4		
Input / Output connectors	4 x balanced Neutrik® XLR female 4 x Neutrik® Speakon NL4MD		
Network data port Ethernet**	1 x RJ45 with activity LED with 2 rotary address switches		
DSP preset selection**	2 x Pushbutton (stepping through bank of 4 presets); 1 x 4 LED preset indicators		
Aux voltage**	1 x 2-pin Phoenix type MC 1.5/2-ST-3.81		
AC mains	IEC C13 16 A connector; AC mains cord with 3-pin plug 15 A for US, IEC Schuko 16 A for every other nation		
Construction			
Dimensions	L x H x W: 483 mm x 44.5 mm x 379 mm / 19" x 1.8" x 14.9"		
Weight	7.4 kg (16 lb)		

\* EIAJ Test Standard, 1 kHz, 1% THD, all channels driven. \*\* HDSP+ETH version only.

## M50Q and M50Q HDSP+ETH

General					
Number of channels	4 mono, bridgable per channel pair				
Max output power per channel*	single channel mode				bridge mode
	4 Ω / Ch	8 Ω / Ch	70 V**	100 V**	8Ω / Ch pair
	1250 W	750 W	1000 W	1250	2500 W
Max output voltage	135V <sub>peak</sub> / 65 A <sub>peak</sub>				270V <sub>peak</sub> / 65 A <sub>peak</sub>
AC Mains Power					
Power supply	Universal, regulated switch mode				
Nominal power requirements	AC 100 V - 240 V (factory selection), 50/60 Hz				
Operating range	AC 90 V - 264 V				
Consumption / current draw	230 V		115 V		
Energy save on	64 W	0.51 A	64 W	0.6 A	
Energy save off	905 W	5.8 A	605 W	11.6 A	
1/8 of max power @ 8 Ω	1772 W	11.1 A	1772 W	22.2 A	
Thermal					
Environmental operating temperature	0° - 45° C / 32° - 113° F				
Thermal dissipation	Fan, variable speed, temperature controlled front to rear airflow				
	230 V				
Idle	218 BTU/h		55 kcal/h		
1/8 of max power @ 4 Ω	955 BTU/h		241 kcal/h		
1/4 of max power @ 4 Ω	1781 BTU/h		449 kcal/h		
Audio					
Gain	32 dB, 30 dB, 28 dB, 26 dB, 24 dB, 22 dB, 20 dB, 18 dB, 14 dB, 4 dB, -∞, user selectable				
Frequency response	20 Hz - 20 kHz ±0.5 dB @ 1 W, 8 Ω				
S/N ratio (amplifier section)	> 110 dB (20 Hz - 20 kHz, A weighted)				
Crosstalk separation	>70 dB @ 1 kHz, 4 Ω				
Input sensitivity @ 8 Ω	1.94 V <sub>rms</sub> / +8 dBu				
Max input level	6 V <sub>rms</sub> / +17.8 dBu				
Input impedance	10 kΩ balanced				
THD+N / DIM100 IMD	< 0.02% (typically <0.005%) @ 4 Ω				
Slew rate	40 V/μs @ 8 Ω input filter bypassed				
Damping factor	> 5000 @ 100 Hz				
DSP***					
A/D converter	CS5381, 2 channels, 24 bit / 48 kHz, 120 dB SNR				
D/A converter	CS4398, 2 channels, 24 bit / 48 kHz, 120 dB SNR				
Frequency response @ -3 dB	7 Hz - 22 kHz				
THD	< 0.01% (20 Hz - 20 kHz)				
Presets	Bank of 4 presets, management and upload via Armonia Pro Audio Suite™				
Delay for time alignment	10 ms per output				
Crossover filters	Butterworth, Linkwitz-Riley, Bessel, 6 dB/oct to 48 dB/oct				
Output equalizer	up to 12 biquad fully parametric per channel: peaking, hi/lo shelving, hi/lo pass, band pass, band stop, all pass.				
Input equalizer	up to 5 biquad filters (PEQ, shelving, band pass, band stop, all pass)				
Limiters	Peak limiter, RMS limiter, frequency dependent RMS limiter				
Damping control	< 120 Hz, range ± 2 Ω				
System Delay	up to 170 ms for 2 IN/2 OUT or 340 ms for 1 IN/ 2 OUT				
Front panel					
Indicators	1 LED bar per channel and 4 status LED				
Controls	1 stepped level attenuator pot per channel; mains switch				
Maintenance	Dust filter foam behind front panels				
Rear panel					
Controls	2 x link switch, linking analog inputs 1&2 and 3&4				
Input / Output connectors	4 x balanced Neutrik® XLR female 4 x Neutrik® Speakon NL4MD				
Network data port Ethernet***	1 x RJ45 with activity LED with 2 rotary address switches				
DSP preset selection***	2 x Pushbutton (stepping through bank of 4 presets); 1 x 4 LED preset indicators				
Aux voltage***	1 x 2-pin Phoenix type MC 1.5/2-ST-3.81				
AC mains	IEC C13 16 A connector; AC mains cord with 3-pin plug 15 A for US, IEC Schuko 16 A for every other nation				
Construction					
Dimensions	L x H x W: 483 mm x 44.5 mm x 379 mm / 19" x 1.8" x 14.9"				
Weight	7.4 kg (16 lb)				

\* EIAJ Test Standard, 1 kHz, 1% THD, all channels driven. \*\* DSP preset or external high-pass and voltage limiter required. \*\*\* HDSP+ETH version only.

## Annex A: IP management and recovery

Through Armonía Pro Audio Suite you can easily set the IP configuration of your M Series amplifiers as long as they are in DHCP or are configured with a static IP on the same Armonía subnet (see [Section 10.1](#)). It may happen that a static IP in a different subnet with respect to Armonía has been assigned to your M Series HDSP+ETH amplifier (i.e. 10.0.x.y versus 169.254.x.y): if this is the case Armonía does not recognize the amplifier. You have to reset the IP configuration of your M Series HDSP+ETH amplifier.

In order to reset the IP configuration of your M Series HDSP+ETH amplifier outside the Armonía environment, follow next instruction.

### A.1 Setting an IP policy on Adu based devices with an external Lantronix tool

M Series HDSP+ETH amplifiers come with one rear RJ45 port for remote device communication, using the IP layer and the UDP protocol. Factory default settings are DHCP/AutoIP, but a fixed IP policy can also be adopted.

#### A.1.1 Reset IP configuration

Adu based devices can be set up with a static IP (or any other IP policy) with an external software programmer provided by Lantronix™. In order to set up the IP address please follow the following steps:

1. Download and install the DeviceInstaller™ software from the Lantronix Web Site on your PC. Please refer to Lantronix documentation.
2. Connect the device to your PC.
3. Shutdown any M Series client (Armonía or third-party client).
4. Launch the program: it should automatically scan your network. If not, manually initiate the scan by clicking the Search button.

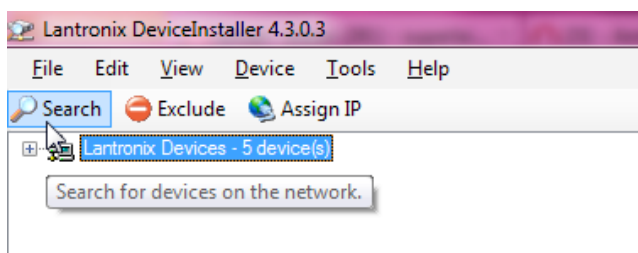

FIGURE A.1 : Lantronix DeviceInstaller – Press the search button to start a (new) search.

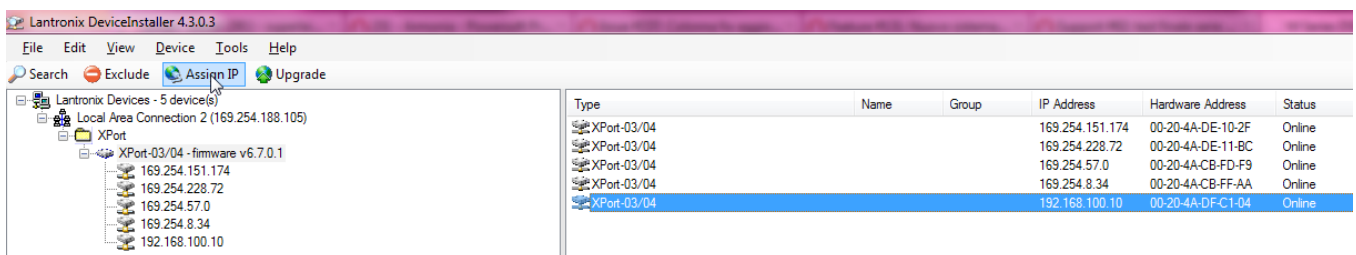

FIGURE A.2 : Select the device and click Assign IP.

**NOTE:** Due to the fact that the Lantronix configurator uses the Ethernet layer no IP set up is necessary.

All the available Lantronix-based devices should appear (see [FIGURE A.2](#)). Please note that devices that are not compatible with the IP network mask of your network interface should appear too due to the fact that the Lantronix Configurator uses the Ethernet stack.

**WARNING! Make sure that the only connected Lantronix-based devices are M Series units. Any third-party device (e.g. printers) that are equipped with a Lantronix unit are visible with this software.**

**Powersoft will be not responsible for any damage suffered by third-party products equipped with Lantronix hardware.**

5. Select the device whose IP address policy you want to set and press the button Assign IP.
6. Follow the Device Installer wizard. Any kind of IP policy can be set.
7. When done, the device network will restart automatically.

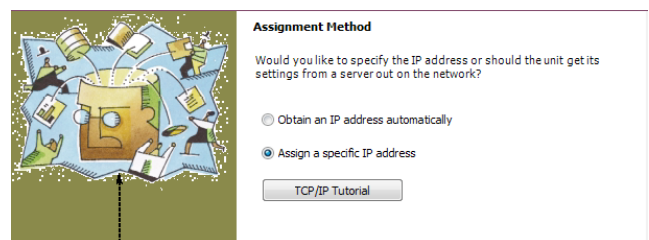

FIGURE A.3 : Select assign specific IP and click next.

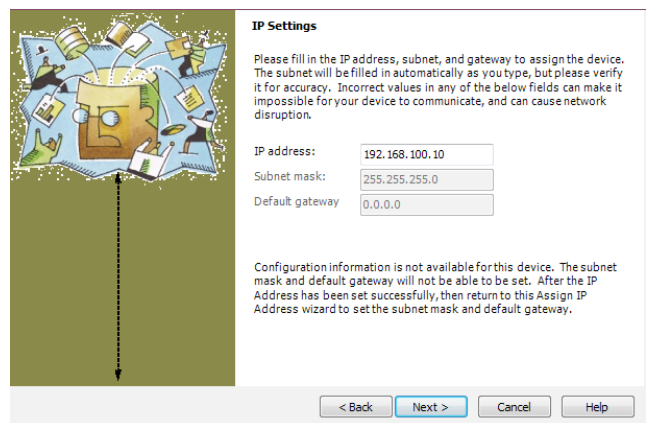

FIGURE A.4 : Select IP address and subnet mask compatible with your PC. Specifying the gateway address is not mandatory. Click next.

Next images display how to set a static IP address.

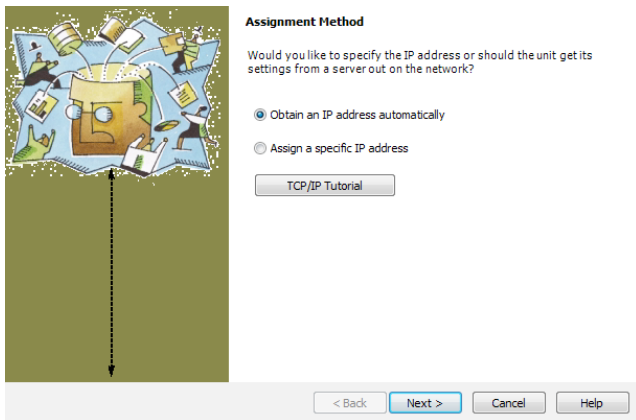

FIGURE A.5 : Select Obtain an IP address and click next.

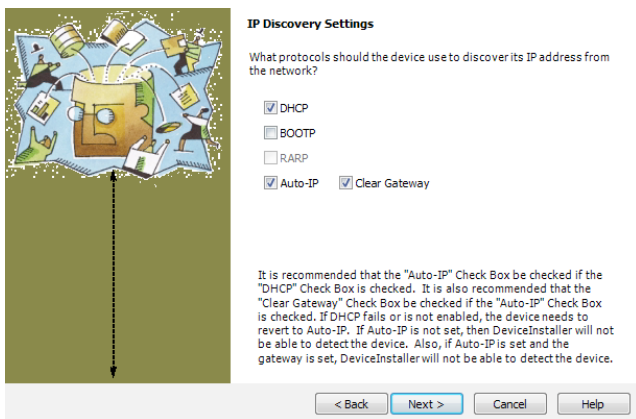

FIGURE A.6 : Set DHCP and Auto IP assignment.



Via Enrico Conti, 5  
50018 Scandicci (FI) Italy

Tel: +39 055 735 0230  
Fax: +39 055 735 6235

General inquiries: [info@powersoft.it](mailto:info@powersoft.it)  
Sales: [sales@powersoft.it](mailto:sales@powersoft.it)  
Application & technical support: [support@powersoft.it](mailto:support@powersoft.it)  
Service & maintenance: [service@powersoft.it](mailto:service@powersoft.it)

[www.powersoft-audio.com](http://www.powersoft-audio.com)